

# Fire-resistance test on fire collars protecting a concrete slab penetrated by services

## Test Report

**Author:** Chris Wojcik  
**Report number:** FSP 1735  
**Date:** 8 September 2016

**Client:** Snap Fire Systems Pty Ltd

Commercial-in-confidence

**Inquiries should be address to:**

Fire Testing and Assessments  
Infrastructure Technologies  
14 Julius Avenue  
North Ryde, NSW 2113  
Telephone +61 2 9490 5444



Author  
Infrastructure Technologies  
14 Julius Avenue  
North Ryde, NSW 2113  
Telephone +61 2 9490 5500

The Client  
Snap Fire Systems Pty Ltd  
Building A, 1343 Wynnum Road  
Tingalpa QLD 4173  
Telephone +61 7 3390 5420

**Report Status and Revision History:**

VERSION	STATUS	DATE	DISTRIBUTION	ISSUE NUMBER
Revision A	Draft for review	12/07/2016	CSIRO/SNAP	FSP 1735
Revision B	Final for issue	08/09/2016	CSIRO/SNAP	FSP 1735

**Report Authorization:**

AUTHOR	REVIEWED BY	AUTHORISED BY
Chris Wojcik	Brett Roddy	Brett Roddy
		
8 September 2016	8 September 2016	8 September 2016

## Use of this Report

### **Use of Reports – Testing**

*This report is subject to binding obligations under which it was prepared. In particular, the Report must not be used:*

- *as a means of endorsement; or*
- *in a company prospectus or notification to a Stock Exchange document for capital raising, without the prior written consent of CSIRO.*

*The Report may be published verbatim and in full, provided that a statement is included on the publication that it is a copy of the Report issued by CSIRO.*

*Excerpts of the Report may not be published.*

### **Use of Reports – Consultancy**

*This report is subject to binding obligations under which it was prepared. In particular, the Report may only be used for the following purposes:*

- *the information in the Report may be used by the party that commissioned the Report for its internal business operations (but not licensing to third parties);*
- *the report may be copied for distribution within the organisation that commissioned the Report;*
- *copies of the Report (or extracts of the Report) may be distributed to contractors and agents of the organisation that commissioned the Report who have a need for the Report for its internal business operations. Any extracts of the Report distributed for this purpose must clearly note that the extract is part of a larger Report held by the organisation that commissioned the Report and which has been prepared by CSIRO.*

*The name, trade mark or logo of the CSIRO must not be used without the prior written consent of CSIRO.*

*The Report must not be used as a means of endorsement without the prior written consent of CSIRO.*

## Copyright and disclaimer

© 2016 CSIRO To the extent permitted by law, all rights are reserved and no part of this publication covered by copyright may be reproduced or copied in any form or by any means except with the written permission of CSIRO.

## Important disclaimer

CSIRO advises that the information contained in this publication comprises general statements based on scientific research. The reader is advised and needs to be aware that such information may be incomplete or unable to be used in any specific situation. No reliance or actions must therefore be made on that information without seeking prior expert professional, scientific and technical advice. To the extent permitted by law, CSIRO (including its employees and consultants) excludes all liability to any person for any consequences, including but not limited to all losses, damages, costs, expenses and any other compensation, arising directly or indirectly from using this publication (in part or in whole) and any information or material contained in it.

# Contents

1	Introduction .....	4
1.1	Identification of specimen .....	4
1.2	Sponsor .....	4
1.3	Manufacturer .....	4
1.4	Test standard .....	4
1.5	Reference standard.....	4
1.6	Test number.....	4
1.7	Test date .....	4
2	Description of specimen .....	5
2.1	General.....	5
2.2	Dimensions .....	5
2.3	Orientation.....	5
2.4	Conditioning.....	5
3	Documentation .....	6
4	Equipment.....	6
4.1	Furnace .....	6
4.2	Temperature .....	6
4.3	Measurement system .....	6
5	Ambient temperature .....	6
6	Departure from standard .....	6
7	Termination of test .....	7
8	Test results .....	7
8.1	Critical observations .....	7
8.2	Furnace temperature.....	7
8.3	Furnace severity.....	7
8.4	Specimen temperature.....	7
8.5	Performance .....	7
9	Fire-resistance level (FRL) .....	8
10	Field of direct application of test results .....	8
11	Tested by .....	8
	Appendices .....	9
	Appendix A – Measurement location .....	9
	Appendix B – Photographs .....	10
	Appendix C – Furnace Temperature .....	13
	Appendix D – Installation drawings.....	16
	Appendix E – Specimen Drawings .....	17
	Appendix F – Certificate(s) .....	18
	References .....	19

# Fire-resistance test on fire collars protecting a concrete slab penetrated by services

## Sponsored Investigation No. FSP 1735

### 1 Introduction

#### 1.1 Identification of specimen

The sponsor identified the specimen as Snap Cast-in Fire Collars protecting a 150-mm thick concrete slab penetrated by four (4) floor wastes and one (1) stack pipe.

#### 1.2 Sponsor

Snap Fire Systems Pty Ltd  
Building A, 1343 Wynnum Road  
Tingalpa QLD 4173

#### 1.3 Manufacturer

Snap Fire Systems Pty Ltd  
Building A, 1343 Wynnum Road  
Tingalpa QLD 4173

#### 1.4 Test standard

Australian Standard 1530, Methods for fire tests on building materials, components and structures, Part 4-2005, Fire-resistance tests of elements of construction.

#### 1.5 Reference standard

Australian Standard 4072, Components for the protection of openings in fire-resistant separating elements, Part 1 - 2005, Service penetrations and control joints.

#### 1.6 Test number

CSIRO Reference test number: FS 4520/3867

#### 1.7 Test date

The fire-resistance test was conducted on 22 September 2015.

## 2 Description of specimen

### 2.1 General

The specimen comprised an 1150-mm x 1150-mm x 150-mm thick reinforced concrete slab penetrated by four (4) floor waste systems and one (1) stack pipe protected by Cast-in Snap Fire System fire collar.

The pipes used in the test are stated to be manufactured in accordance with:

- AS/NZS 1260 - PVC-U pipes and fittings for drain, waste and vent application; and
- AS/NZS 7671:2010 'Plastics piping systems for soil and waste discharge (low and high temperature) inside buildings - Polypropylene (PP)(ISO 7671:2003), MOD';

For the purpose of the test, the specimens were referenced as Penetrations 1, 2, 3, 4 and 5. Only one (1) specimen is included in this report (Penetration 3). Documents containing a complete description of each specimen were supplied by the sponsor and are retained on file.

#### Penetration 3 – H65S-RR cast-in fire collar protecting a 42-mm diameter Polyvinyl Chloride (PVC) pipe with a fitting inside the collar

The SNAP Cast-in H65S-RR fire collar comprised a 1.6-mm thick polypropylene casing with a 84-mm inner diameter and a 168-mm diameter base flange. The 250-mm high collar casing incorporated a 280-mm x 65-mm x 5-mm thick Intumesh intumescent material and a rubber ring seal. The closing mechanism comprised three galvanised steel springs bound with nylon fuse links and a 322-mm x 65-mm stainless steel mesh as shown in drawing numbered H65S-RR-T dated 29 September 2015, by SNAP Fire Systems Pty Ltd.

The penetrating service comprised a 42.5-mm PVC stack pipe and a 40-mm PVC Coupling, with a total wall thickness of 5-mm fitted through the collar's sleeve. The pipe projected vertically 2000-mm above the concrete and 500-mm into the furnace chamber. The pipe was supported at 500-mm and 1500-mm from the unexposed face of the concrete slab as shown in drawing titled "Test Slab S-15-F Penetration # 3 – 42.5-mm PVC Stack Pipe & H65S-RR & Fitting Inside the Collar" dated 6 January 2016, by Snap Fire Systems Pty Ltd. On the exposed end, the pipe was capped with a 40-mm PVC End Cap.

On the unexposed face, the annular gap between the pipe and slab was sealed with non-shrink grout backfill.

### 2.2 Dimensions

The overall dimension of the concrete slab was 1150-mm wide x 1150-mm long, to suit the opening in the specimen containing frame.

### 2.3 Orientation

The reinforced concrete slab was placed horizontally on top of the furnace chamber, and subjected to fire exposure from the underside.

### 2.4 Conditioning

The concrete slab was left to cure for a period longer than 30 days.

## 3 Documentation

The following documents were supplied or referenced by the sponsor as a complete description of the specimen and should be read in conjunction with this report:

Drawing titled “Test Slab S-15-F Penetration # 3 – 42.5-mm PVC Stack Pipe & H65S-RR & Fitting Inside the Collar” dated 6 January 2016, by Snap Fire Systems Pty Ltd.

Drawing numbered H65S-RR-T, dated 29 September 2015, by Snap Fire Systems Pty Ltd.

## 4 Equipment

### 4.1 Furnace

The furnace had a nominal opening of 1000-mm x 1000-mm for attachment of vertical or horizontal specimens.

The furnace was lined with refractory bricks and materials with the thermal properties as specified in AS 1530.4-2005 and was heated by combustion of a mixture of natural gas and air.

### 4.2 Temperature

The temperature in the furnace chamber was measured by four type K, 3-mm diameter, and 310 stainless steel Mineral Insulated Metal Sheathed (MIMS) thermocouples. Each thermocouple was housed in high-nickel steel tubes opened at the exposed end.

The temperatures of the specimen were measured by glass-fibre insulated and sheathed K-type thermocouples with a wire diameter of 0.5-mm.

Location of the thermocouples on the unexposed face of the specimen are described in Appendix A.

### 4.3 Measurement system

The primary measurement system comprised a multiple-channel data logger, scanning at one minute intervals during the test.

## 5 Ambient temperature

The temperature of the test area was 17°C at the commencement of the test.

## 6 Departure from standard

There were no departures from the requirements of AS 1530.4-2005.

## 7 Termination of test

The test was terminated at 241 minutes by the agreement with the sponsor.

## 8 Test results

### 8.1 Critical observations

The following observations were made during the fire-resistance test:

Time	Observation
60 minutes -	No apparent change to the specimen.
120 minutes -	No apparent change to the specimen.
180 minutes -	No apparent change to the specimen.
241 minutes -	No apparent change to the specimen. Test terminated

### 8.2 Furnace temperature

Figure 1 shows the standard curves of temperature versus time for heating the furnace chamber and the actual curves of average and maximum temperature versus time recorded during the heating period.

### 8.3 Furnace severity

Figure 2 shows the curve of furnace severity versus time during the heating period.

### 8.4 Specimen temperature

Figure 3 shows the curve of maximum temperature versus time associated with Penetration 3.

### 8.5 Performance

Performance observed in respect of the following AS 1530.4-2005 criteria:

Penetration 3 – H65S-RR cast-in fire collar protecting a 42-mm diameter Polyvinyl Chloride (PVC) pipe with a fitting inside the collar

Structural adequacy	-	not applicable
Integrity	-	no failure at 241 minutes
Insulation	-	no failure at 241 minutes



This report details methods of construction, the test conditions and the results obtained when the specific element of construction described herein was tested following the procedure outlined in this standard. Any significant variation with respect to size, constructional details, loads, stresses, edge or end conditions, other than those allowed under the field of direct application in the relevant test method, is not covered by this report.

Because of the nature of fire resistance testing and the consequent difficulty in quantifying the uncertainty of measurement of fire resistance, it is not possible to provide a stated degree of accuracy of the result.

## 9 Fire-resistance level (FRL)

For the purpose of building regulations in Australia, the FRL's of the test specimens were as follows:

Penetration 3 - -/240/240

The fire-resistance level of the penetration system is applicable when the system is exposed to fire from the same side as tested.

For the purposes of AS 1530.4-2005 the results of these fire tests may be used to directly assess fire hazard, but it should be noted that a single test method will not provide a full assessment of fire hazard under all fire conditions.

## 10 Field of direct application of test results

The results of the fire test contained in this test report are directly applicable, without reference to the testing authority, to similar constructions where one or more changes listed in Clause 10.11 of AS 1530.4-2005, have been made provided no individual component is removed or reduced.

## 11 Tested by

Chris Wojcik  
Testing Officer

# Appendices

## Appendix A – Measurement location

Measurement Location		
Group location	T/C Position	T/C designation
Specimen		
Penetration 3	On the concrete – 25-mm from the mortar.	S7
	On the concrete – 25-mm from the mortar	S8
	On the mortar next to the pipe.	S9
	On the mortar next to the pipe.	S10
	On pipe – 25-mm from the base.	S11
	On pipe – 25-mm from the base.	S12

Appendix B – Photographs



PHOTOGRAPH 1 – EXPOSED FACE OF SPECIMEN PRIOR TO TESTING

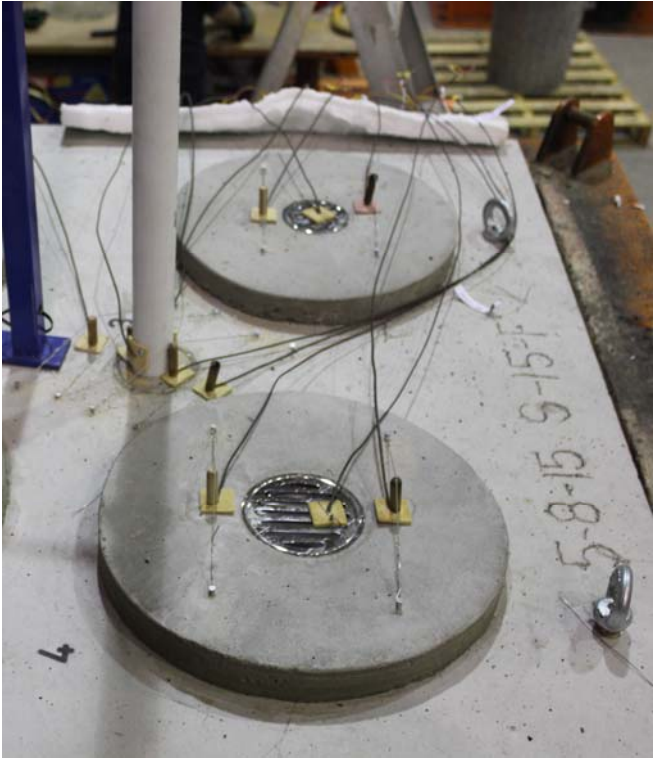

PHOTOGRAPH 2 – UNEXPOSED FACE OF SPECIMENS PRIOR TO TESTING



**PHOTOGRAPH 3 – SPECIMENS AFTER 60 MINUTES OF TESTING**



**PHOTOGRAPH 4 – SPECIMENS AFTER 120 MINUTES OF TESTING**



**PHOTOGRAPH 5 – SPECIMENS AFTER 180 MINUTES OF TESTING**



**PHOTOGRAPH 6 – EXPOSED FACE OF SPECIMENS AT CONCLUSION OF TESTING**

## Appendix C – Furnace Temperature

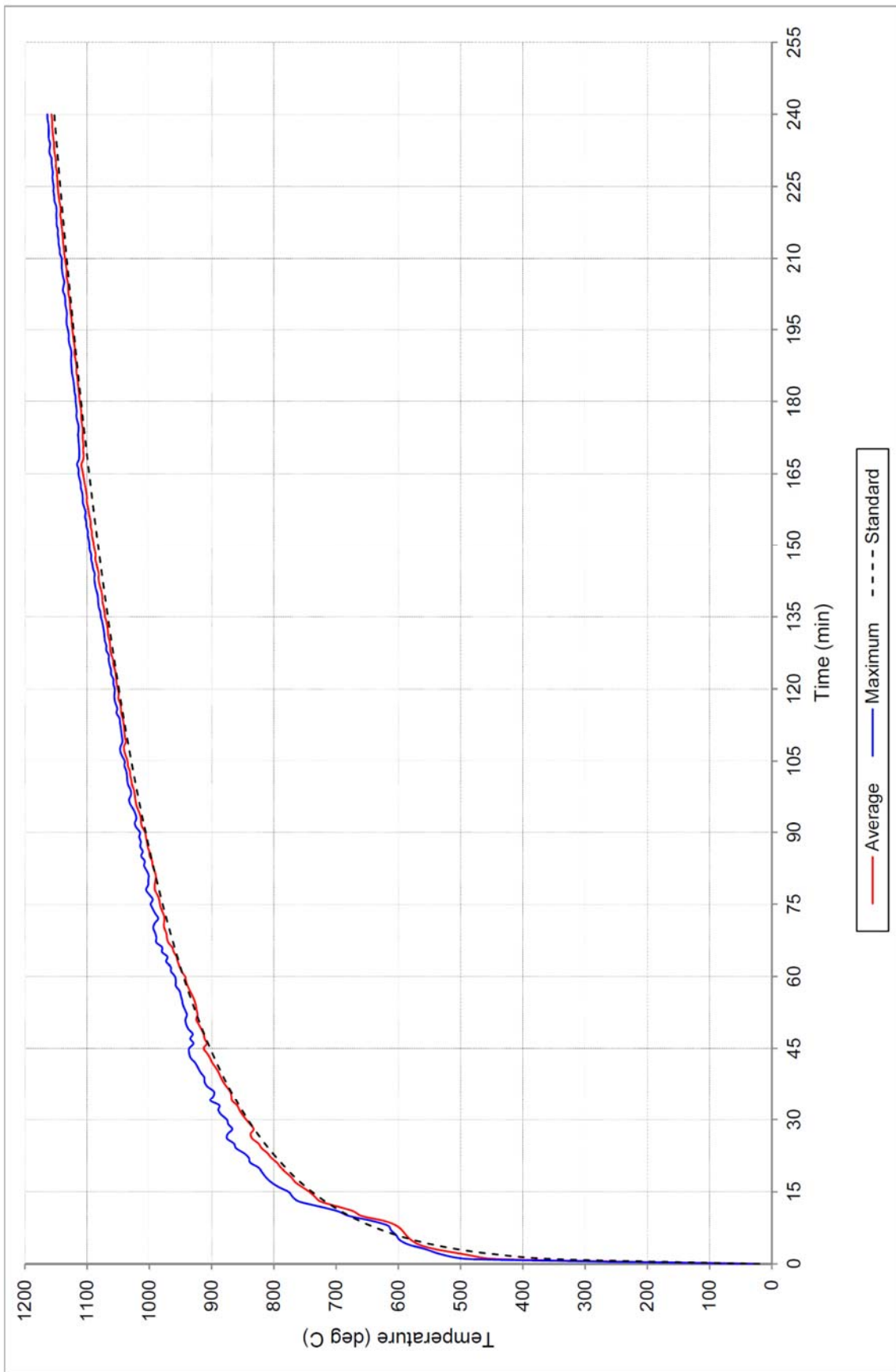

FIGURE 1 – FURNACE TEMPERATURE

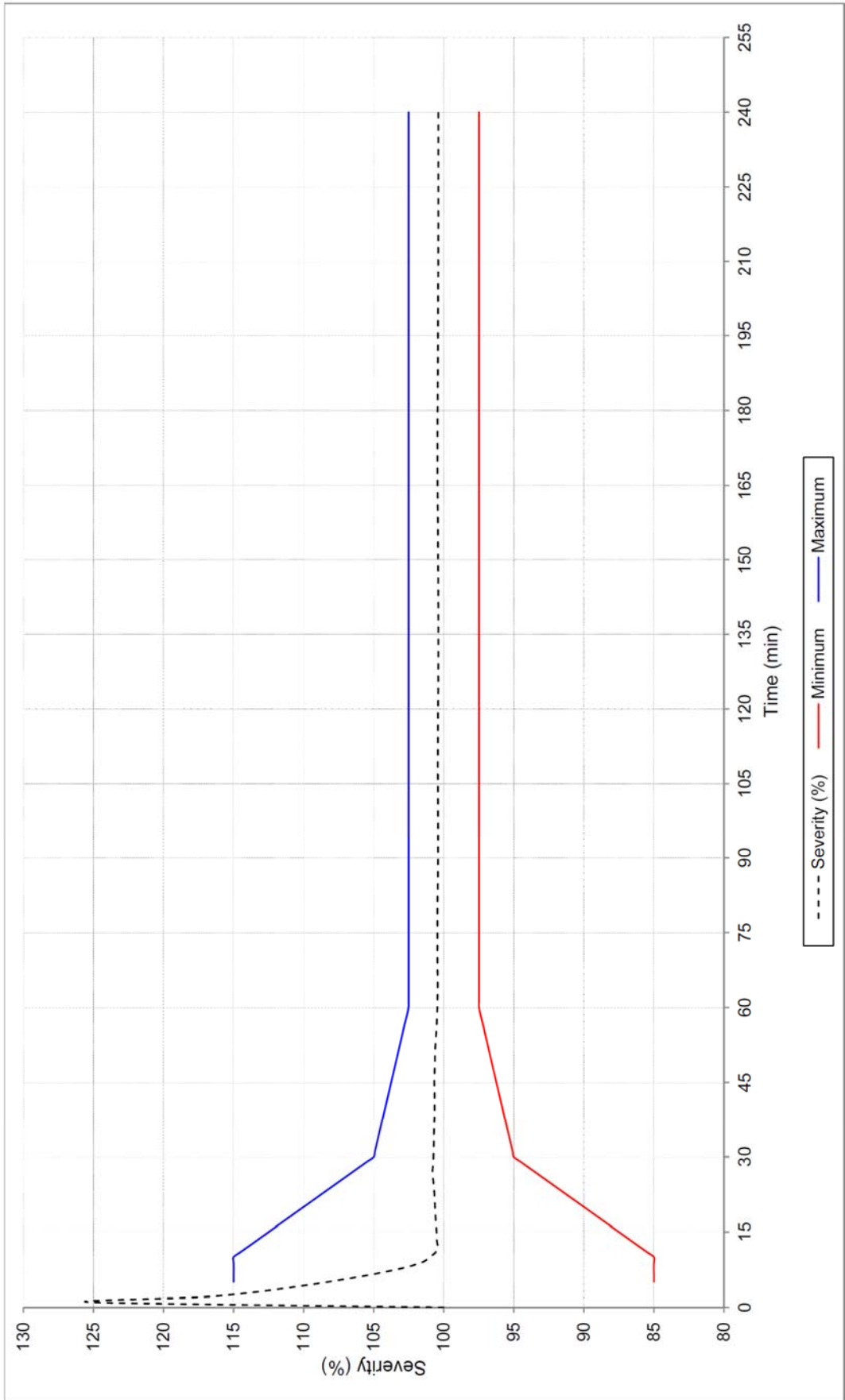

FIGURE 2 – FURNACE SEVERITY

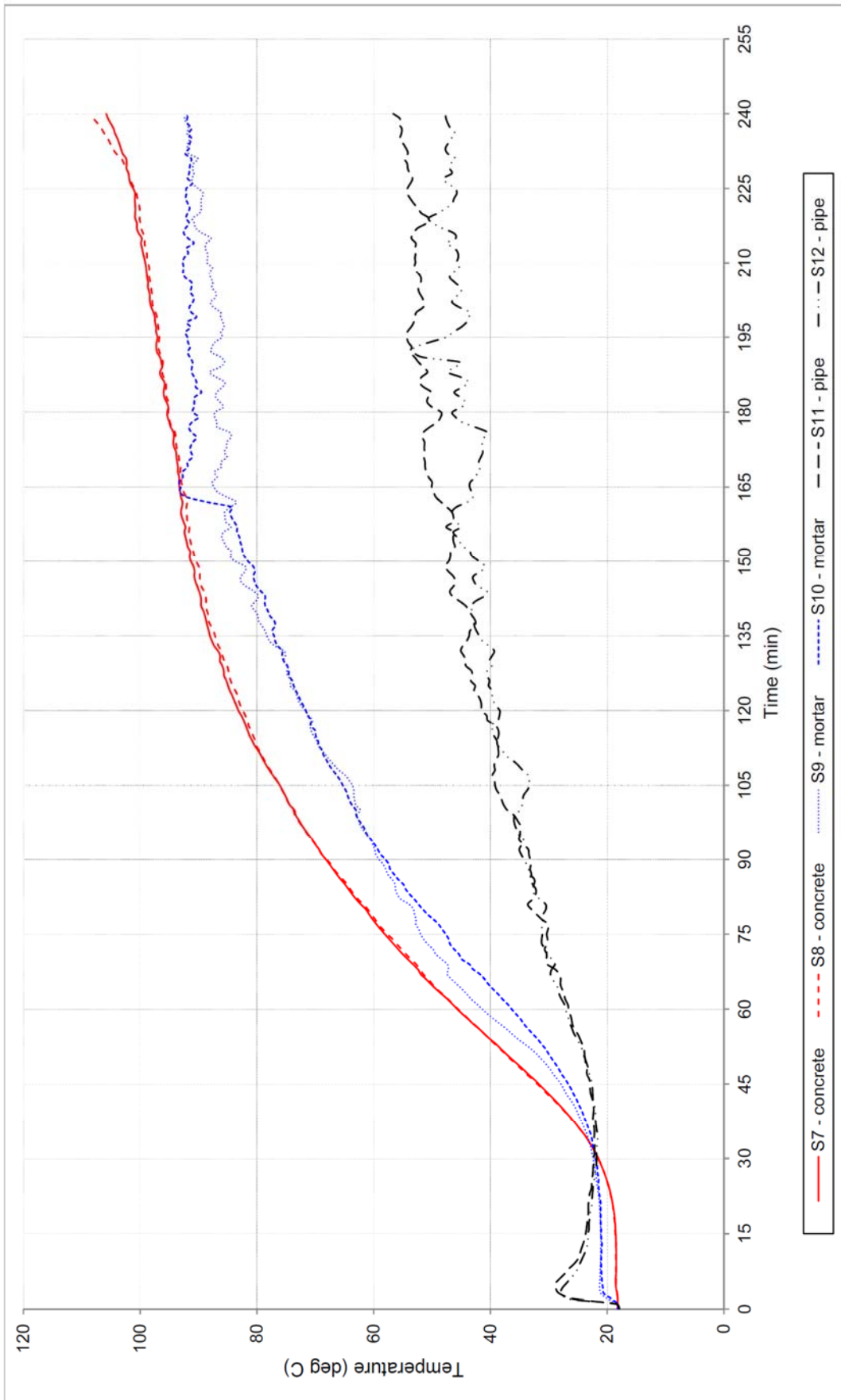
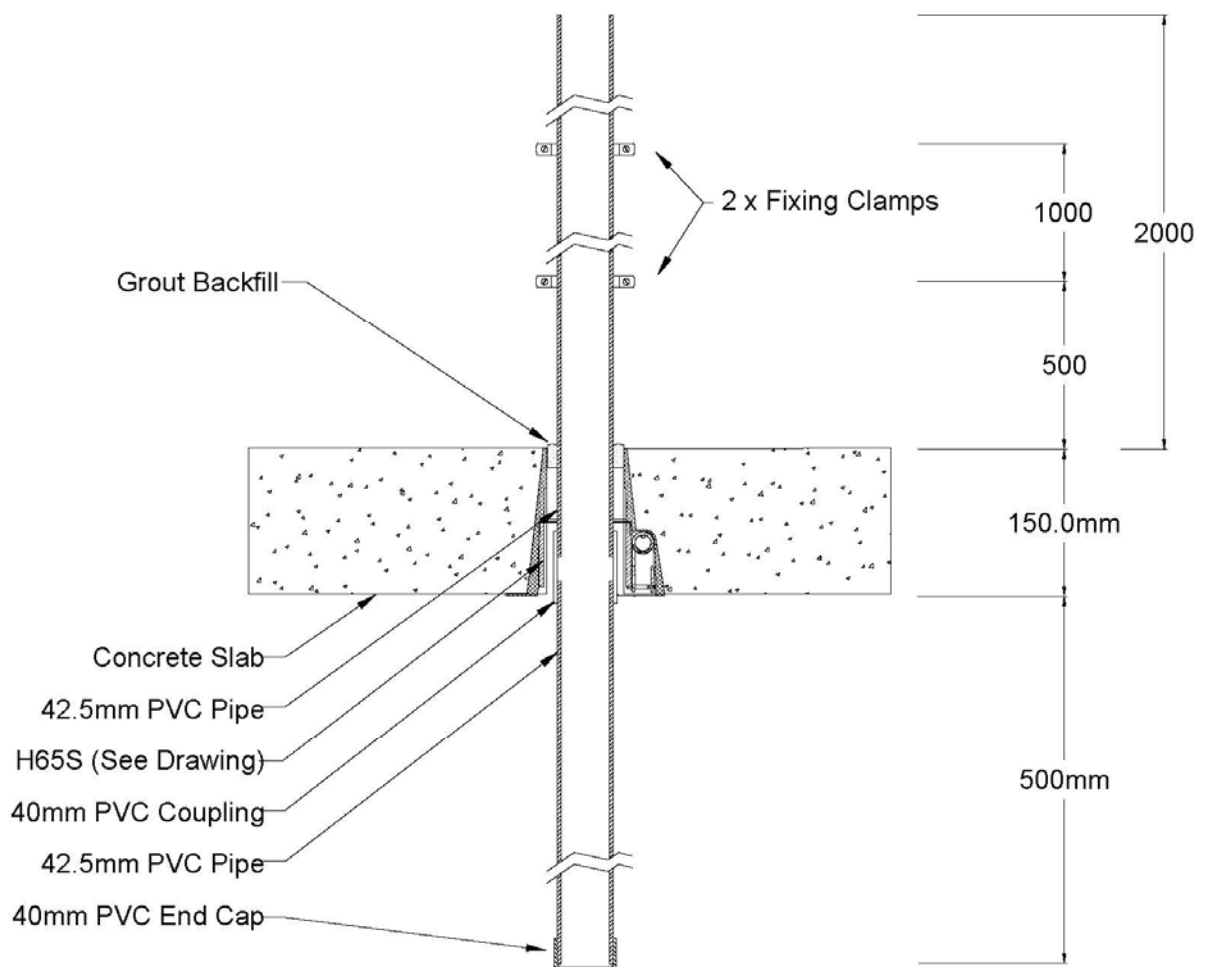

FIGURE 3 – SPECIMEN TEMPERATURE – ASSOCIATED WITH PENETRATION 3



## Appendix D – Installation drawings

Test Slab S-15-F Penetration # 3  
42.5mm PVC Stack Pipe & H65S & Fitting Inside The Collar  
Date: 06 Jan 2016



**DRAWING TITLED "TEST SLAB S-15-F PENETRATION # 3 – 42.5-MM PVC STACK PIPE – H65S-RR" DATED 6 JANUARY 2016, BY SNAP FIRE SYSTEMS PTY LTD.**

# Appendix E – Specimen Drawings

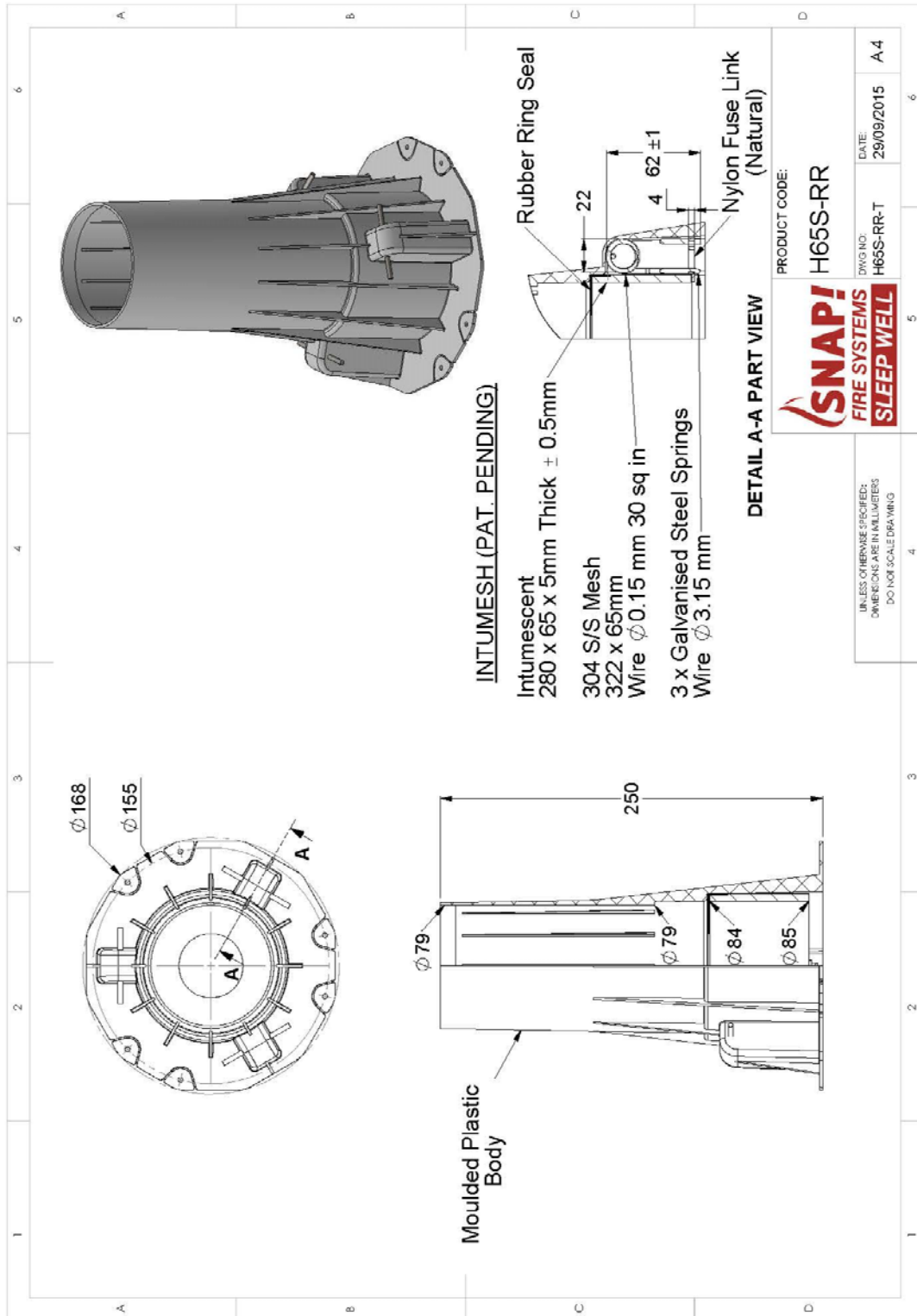

DRAWING NUMBERED H65S-RR-T, DATED 29 SEPTEMBER 2015, BY SNAP FIRE SYSTEMS PTY LTD.

# Appendix F – Certificate(s)

<b>INFRASTRUCTURE TECHNOLOGIES</b> <a href="http://www.csiro.au">www.csiro.au</a>		
14 Julius Avenue, North Ryde NSW 2113 PO Box 52, North Ryde NSW 1670, Australia T (02) 9490 5444 • ABN 41 687 119 230		
<h2>Certificate of Test</h2>		No. 2840
<small>“Copyright CSIRO 2016 ©” Copying or alteration of this report without written authorisation from CSIRO is forbidden.</small>		
This is to certify that the element of construction described below was tested by the CSIRO Division of Materials Science and Engineering in accordance with Australian Standard 1530, Methods for fire tests on building materials, components and structures, Part 4-2005 on behalf of:		
Snap Fire Systems Pty Ltd Building A, 1343 Wynnum Road Tingalpa QLD		
A full description of the test specimen and the complete test results are detailed in the Division's Sponsored Investigation report numbered FSP 1735.		
Product Name:	Penetration 3 – H65S-RR cast-in fire collar protecting a 42-mm diameter Polyvinyl Chloride (PVC) pipe with a fitting inside the collar	
Description:	The SNAP Cast-in H65S-RR fire collar comprised a 1.6-mm thick polypropylene casing with a 84 mm inner diameter and a 168-mm diameter base flange. The 250-mm high collar casing incorporated a 280 mm x 65 mm x 5-mm thick Intumescent material and a rubber ring seal. The closing mechanism comprised three galvanised steel springs bound with nylon fuse links and a 322 mm x 65-mm stainless steel mesh as shown in drawing numbered H65S-RR-T dated 29 September 2015, by SNAP Fire Systems Pty Ltd. The penetrating service comprised a 42.5-mm PVC stack pipe and a 40-mm PVC Coupling, with a total wall thickness of 5 mm fitted through the collar's sleeve. The pipe projected vertically 2000-mm above the concrete and 500 mm into the furnace chamber. The pipe was supported at 500-mm and 1500 mm from the unexposed face of the concrete slab as shown in drawing titled “Test Slab S-15-F Penetration # 3 – 42.5-mm PVC Stack Pipe & H65S-RR & Fitting Inside the Collar” dated 6 January 2016, by Snap Fire Systems Pty Ltd. On the exposed end, the pipe was capped with a 40-mm PVC End Cap. On the unexposed face, the annular gap between the pipe and slab was sealed with non-shrink grout backfill.	
Structural Adequacy	not applicable	
Integrity	no failure at 241 minutes	
Insulation	no failure at 241 minutes	
and therefore for the purpose of Building Regulations in Australia, achieved a fire-resistance level (FRL) of -/240/240. The FRL is applicable for exposure to the fire from the same direction as tested. This certificate is provided for general information only and does not comply with regulatory requirements for evidence of compliance.		
Testing Officer:	Chris Wojcik	Date of Test: 22 September 2015
Issued on the 8 <sup>th</sup> day of September 2016 without alterations or additions.		
		
Brett Roddy Manager, Fire Testing and Assessments		
	This document is issued in accordance with NATA's accreditation requirements. Accreditation No. 165 – Corporate Site No. 3625 Accredited for compliance with ISO/IEC 17025	

**COPY OF CERTIFICATE OF TEST – NO. 2840**

# References

The following informative documents are referred to in this Report:

- |                |   |
|----------------|---|
| AS 1530.4-2005 | Methods for fire tests on building materials, components and structures Part 4: Fire-resistance tests of elements of building construction. |
| AS 4072.1-2005 | Components for the protection of openings in fire-resistant separating elements. Part 1: Service penetrations and control joints.           |

**----end of report----**

#### CONTACT US

**t** 1300 363 400  
+61 3 9545 2176  
**e** [enquiries@csiro.au](mailto:enquiries@csiro.au)  
**w** [www.csiro.au](http://www.csiro.au)

#### YOUR CSIRO

Australia is founding its future on science and innovation. Its national science agency, CSIRO, is a powerhouse of ideas, technologies and skills for building prosperity, growth, health and sustainability. It serves governments, industries, business and communities across the nation.

#### FOR FURTHER INFORMATION

##### **Infrastructure Technologies**

Brett Roddy  
Team Leader, Fire Testing and Assessments  
**t** +61 2 94905449  
**e** [brett.rodny@csiro.au](mailto:brett.rodny@csiro.au)  
**w** [www.csiro.au/Organisation-Structure/Divisions/CMSE/Infrastructure-Technologies/Fire-safety.aspx](http://www.csiro.au/Organisation-Structure/Divisions/CMSE/Infrastructure-Technologies/Fire-safety.aspx)