



**BRANZ**

1222 Moonshine Road  
Judgeford RD1  
Porirua 5381  
New Zealand  
T +64 4 237 1170  
F +64 4 237 1171  
branz@branz.co.nz  
www.branz.co.nz



# FIRE TEST REPORT

## FR 5670

FIRE RESISTANCE OF PIPE PENETRATIONS IN A 150 MM THICK CONCRETE FLOOR SLAB

### CLIENT

Snap Fire Systems Pty Ltd  
Building A  
1343 Wynnum Road  
Tingalpa  
QLD 4173  
Australia



**IANZ**  
ACCREDITED LABORATORY

This Laboratory is accredited by International Accreditation New Zealand (IANZ). The tests reported herein have been performed in accordance with the laboratory's scope of accreditation.

PROJECT NUMBER:

**FT5670**

ISSUE DATE:

**6 September 2016**

PAGE:

**1 of 65**

THE LEGAL VALIDITY OF THIS REPORT CAN ONLY BE CLAIMED ON PRESENTATION OF THE COMPLETE SIGNED PAPER REPORT.  
EXTRACTS OR ABRIDGMENTS OF THIS REPORT SHALL NOT BE PUBLISHED WITHOUT PERMISSION FROM BRANZ LTD.

# TEST SUMMARY

## Objective

To determine the fire resistance of pipe penetration sealing systems in accordance with AS 1530.4-2005 *Fire Resistance tests of elements of building construction: Section 10 Service Penetrations and Control Joints*, with reference to AS 4072.1-2005.

## Test sponsor

Snap Fire Systems Pty Ltd  
Building A  
1343 Wynnum Road  
Tingalpa  
QLD 4173  
Australia

## Description of test specimen

The test floor comprised a 150 mm reinforced concrete floor slab.

The slab was fitted with 27 penetrations of which 19 were cast in collars at the time of laying the slab and the remaining 8 into drilled holes.

The pipes ranged in diameter from 16 mm to 160 mm OD and the materials included PVC, HDPE, Raupiano, Pex-a and Pex-b.

## Date of test

3 March 2016

## Test results

The fire resistance in minutes, in accordance with AS 1530.4-2005, of 29 pipe penetrations and their sealing systems in a 150 mm thick reinforced concrete slab, was as follows:

Specimen No.	Collar	Pipe	Size (Nom, mm)	Integrity, min	Insulation, min	FRL
1	LP100R-C	PVC	80	216	159	-/180/120
2	H100FWS-RR	PVC-SC	100	245 NF	245 NF	-/240/240
3	H50FWS-RR	PVC	50	245 NF	245 NF	-/240/240
4	H150S-RR	PVC-SC	160	245 NF	200	-/240/180
5	H150S-RR	HDPE	160	195	125	-/180/120
6	H150S-RR	Raupiano	160	245 NF	203	-/240/180
7	H150S-RR	BEP PVC-U-SC	110	245 NF	245 NF	-/240/240



REPORT NUMBER:

**FR 5670**

ISSUE DATE:

**6 September 2016**

PAGE:

**2 of 65**

PCRC

ES

Specimen No.	Collar	Pipe	Size (Nom, mm)	Integrity, min	Insulation, min	FRL
8	H150S-RR	HDPE	125	245 NF	245 NF	-/240/240
9	H150S-RR	Raupiano	100	245 NF	207	-/240/180
10	32R	Pex-a	16	245 NF	213	-/240/180
11	32R	Pex-a	20	245 NF	245 NF	-/240/240
12	32R	Pex-a	25	245 NF	245 NF	-/240/240
13	32R	Pex-b	16	245 NF	245 NF	-/240/240
14	32R	Pex-b	20	245 NF	245 NF	-/240/240
15	32R	Pex-b	25	245 NF	245 NF	-/240/240
16	H50S-RR	Pex-a	16	245 NF	245 NF	-/240/240
17	H50S-RR	Pex-b	16	245 NF	245 NF	-/240/240
18	H50S-RR	Pex-a	20	245 NF	245 NF	-/240/240
19	H50S-RR	Pex-b	20	245 NF	245 NF	-/240/240
20	H100FWS-RR	Blank, 0.4 mm galv steel plate	110	245 NF	245 NF	-/240/240
22	H100FWS-RR	BEP PVC-U-SC	110	245 NF	245 NF	-/240/240
23	H100S-RR	PVC-U	65	245 NF	73	-/240/60
24	H50S-RR	PVC	40	245 NF	164	-/240/120
26	H50FWS-RR	HDPE	50	245 NF	245 NF	-/240/240
27	LP50R	PVC	40	245 NF	178	-/240/120
28	H65S-RR	HDPE	40	245 NF	245 NF	-/240/240
29	H50S-RR	PVC-U	32	245 NF	245 NF	-/240/240

The test standard requires the following statements to be included:

*"The results of these fire tests may be used to directly assess fire hazard, but it should be recognized that a single test method will not provide a full assessment of fire hazard under all fire conditions."*

*"This report details methods of construction, the test conditions and results obtained when the specific element of construction described herein was tested following the procedure outlined in this standard. Any significant variations with respect to size, constructional details, loads, stresses, edge or end conditions, other than those allowed under the field of direct application in the relevant test method, is not covered by this report."*

*"Because of the nature of fire resistance testing and the consequent difficulty in quantifying the uncertainty of measurement of fire resistance, it is not possible to provide a stated degree of accuracy of the result."*



REPORT NUMBER:

**FR 5670**

ISSUE DATE:

**6 September 2016**

PAGE:

**3 of 65**



## LIMITATION

The results reported here relate only to the item/s tested.

## TERMS AND CONDITIONS

This report is issued in accordance with the Terms and Conditions as detailed and agreed in the BRANZ Services Agreement for this work.



REPORT NUMBER:

**FR 5670**

ISSUE DATE:

**6 September 2016**

PAGE:

**4 of 65**

PCRC

*PCRC*

ES

*[Signature]*

THE LEGAL VALIDITY OF THIS REPORT CAN ONLY BE CLAIMED ON PRESENTATION OF THE COMPLETE SIGNED PAPER REPORT.  
EXTRACTS OR ABRIDGMENTS OF THIS REPORT SHALL NOT BE PUBLISHED WITHOUT PERMISSION FROM BRANZ LTD.



## TO WHOM IT MAY CONCERN

Both NATA (National Association of Testing Authorities, Australia) and IANZ (International Accreditation New Zealand) are signatories to the ILAC Mutual Recognition Arrangement. Under the terms of this arrangement, each signatory:

- (i) recognises within its scope of recognition of this Arrangement the accreditation of an organisation by other signatories as being equivalent to an accreditation by its own organisation,
- (ii) accepts, for its own purposes, endorsed\* certificates or reports issued by organisations accredited by other signatories on the same basis as it accepts endorsed\* certificates or reports issued by its own accredited organisations,
- (iii) recommends and promotes the acceptance by users in its economy of endorsed\* certificates and reports,

\* The word "endorsed" means a certificate or report bearing an Arrangement signatory's accreditation symbol (or mark) preferably combined with the ILAC-MRA Mark.

Signed:

Jennifer Evans  
NATA CEO

Date: 24 March 2014

Dr Llewellyn Richards  
IANZ CEO

Date: 24<sup>th</sup> March 2014



REPORT NUMBER:

**FR 5670**

ISSUE DATE:

**6 September 2016**

PAGE:

**5 of 65**

PCRC

ES

# CONTENTS

<b>SIGNATORIES</b> .....	<b>10</b>
<b>DOCUMENT REVISION STATUS</b> .....	<b>10</b>
<b>1. TEST PROCEDURE</b> .....	<b>11</b>
1.1 Integrity .....	11
1.2 Insulation .....	11
<b>2. DESCRIPTION OF TEST SPECIMEN</b> .....	<b>11</b>
2.1 General .....	11
2.2 Penetration details.....	11
2.2.1 Pipe support spacing .....	11
2.2.2 Pipe specification .....	11
2.2.3 Penetration seal details .....	13
2.2.3.1 Cast in collars .....	13
2.2.3.2 Retrofit collars .....	17
<b>3. TEST CONDITIONS AND RESULTS</b> .....	<b>22</b>
3.1 General .....	22
3.2 Furnace temperature measurement .....	22
3.3 Furnace control .....	23
3.4 Pressure measurement .....	23
3.5 Specimen temperature measurement .....	24
3.6 Specimen insulation.....	39
3.7 Observations.....	40
3.7.1 Integrity.....	46
<b>4. CONCLUSION</b> .....	<b>47</b>
<b>5. PERMISSIBLE VARIATIONS</b> .....	<b>48</b>
<b>PHOTOS</b> .....	<b>49</b>



REPORT NUMBER:

**FR 5670**

ISSUE DATE:

**6 September 2016**

PAGE:

**6 of 65**



# FIGURES

Figure 1: H100FWS-RR collar (specimens 2, 20 to 22 and 25)	14
Figure 2: H50FWS-RR (specimens 3 and 26)	14
Figure 3: H50S-RR collar (specimens 16 to 19, 24 and 29)	15
Figure 4: H65S-RR collar (specimen 28)	15
Figure 5: H150 S-RR collar (specimens 4 to 9)	16
Figure 6: H100S-RR (specimen 23)	16
Figure 7: LP100R-C (specimen 1)	17
Figure 8: 32R collar (specimens 10 to 15)	18
Figure 9: LP50R (specimen 27)	18
Figure 10: Test specimen showing location of penetrations	21
Figure 11: Furnace Temperature	22
Figure 12: Deviation of mean furnace temperature	23
Figure 13: Furnace pressure	24
Figure 14: Specimen 1 temperature rise	25
Figure 15: Specimen 2 temperature rise	26
Figure 16: Specimen 3 temperature rise	26
Figure 17: Specimen 4 temperature rise	27
Figure 18: Specimen 5 temperature rise	27
Figure 19: Specimen 6 temperature rise	28
Figure 20: Specimen 7 temperature rise	28
Figure 21: Specimen 8 temperature rise	29
Figure 22: Specimen 9 temperature rise	29
Figure 23: Specimen 10 temperature rise	30
Figure 24: Specimen 11 temperature rise	30
Figure 25: Specimen 12 temperature rise	31
Figure 26: Specimen 13 temperature rise	31
Figure 27: Specimen 14 temperature rise	32
Figure 28: Specimen 15 temperature rise	32
Figure 29: Specimen 16 temperature rise	33
Figure 30: Specimen 17 temperature rise	33
Figure 31: Specimen 18 temperature rise	34
Figure 32: Specimen 19 temperature rise	34
Figure 33: Specimen 20 temperature rise	35
Figure 34: Specimen 22 temperature rise	35
Figure 35: Specimen 23 temperature rise	36
Figure 36: Specimen 24 temperature rise	36
Figure 37: Specimen 26 temperature rise	37
Figure 38: Specimen 27 temperature rise	37
Figure 39: Specimen 28 temperature rise	38
Figure 40: Specimen 29 temperature rise	38
Figure 41: Temperature rise on concrete slab	39



REPORT NUMBER:

**FR 5670**

ISSUE DATE:

**6 September 2016**

PAGE:

**7 of 65**



## TABLES

Table 1: Specimen pipe details .....	12
Table 2: Pipe collars .....	19
Table 3: Specimen Insulation failures .....	39

## PHOTOS

Photo 1: Pre-test unexposed face Specimens 1 to 6.....	49
Photo 2: Pre-test unexposed face Specimens 7 to 15.....	49
Photo 3: Pre-test unexposed face Specimens 16 to 20.....	50
Photo 4: Pre-test unexposed face Specimens 22 to 29.....	50
Photo 5: Pre-test exposed face.....	51
Photo 6: Start of test unexposed face .....	51
Photo 7: Specimen 1, left to right, unexposed, exposed and unexposed post test ..	52
Photo 8: Specimen 2, left to right, unexposed, exposed and unexposed post test ..	52
Photo 9: Specimen 3, left to right, unexposed, exposed and unexposed post test ..	53
Photo 10: Specimen 4, left to right, unexposed, exposed and unexposed post test	53
Photo 11: Specimen 5, left to right, unexposed, exposed and unexposed post test	54
Photo 12: Specimen 6, left to right, unexposed, exposed and unexposed post test	54
Photo 13: Specimen 7, left to right, unexposed, exposed and unexposed post test	55
Photo 14: Specimen 8, left to right, unexposed, exposed and unexposed post test	55
Photo 15: Specimen 9, left to right, unexposed, exposed and unexposed post test	56
Photo 16: Specimen 10, left to right, unexposed, exposed and unexposed post test .....	56
Photo 17: Specimen 11, left to right, unexposed, exposed and unexposed post test .....	57
Photo 18: Specimen 12, left to right, unexposed, exposed and unexposed post test .....	57
Photo 19: Specimen 13, left to right, unexposed, exposed and unexposed post test .....	58
Photo 20: Specimen 14, left to right, unexposed, exposed and unexposed post test .....	58
Photo 21: Specimen 15, left to right, unexposed, exposed and unexposed post test .....	59
Photo 22: Specimen 16, left to right, unexposed, exposed and unexposed post test .....	59
Photo 23: Specimen 17, left to right, unexposed, exposed and unexposed post test .....	60
Photo 24: Specimen 18, left to right, unexposed, exposed and unexposed post test .....	60



REPORT NUMBER:

**FR 5670**

ISSUE DATE:

**6 September 2016**

PAGE:

**8 of 65**





Photo 25: Specimen 19, left to right, unexposed, exposed and unexposed post test .....61

Photo 26: Specimen 20, left to right, unexposed, exposed and unexposed post test .....61

Photo 27: Specimen 22, left to right, unexposed, exposed and unexposed post test .....62

Photo 28: Specimen 23, left to right, unexposed, exposed and unexposed post test .....62

Photo 29: Specimen 24, left to right, unexposed, exposed and unexposed post test .....63

Photo 30: Specimen 26, left to right, unexposed, exposed and unexposed post test .....63

Photo 31: Specimen 27, left to right, unexposed, exposed and unexposed post test .....64

Photo 32: Specimen 28, left to right, unexposed, exposed and unexposed post test .....64

Photo 33: Specimen 29, left to right, unexposed, exposed and unexposed post test .....65



REPORT NUMBER:

**FR 5670**

ISSUE DATE:

**6 September 2016**

PAGE:

**9 of 65**



## SIGNATORIES



**Author**

P. C. R. Collier  
Senior Fire Testing Engineer



**Reviewer**

E. Soja  
Senior Fire Safety Engineer  
IANZ Approved Signatory

## DOCUMENT REVISION STATUS

ISSUE NO.	DATE ISSUED	DESCRIPTION
1	6 September 2016	Initial Issue



REPORT NUMBER:

**FR 5670**

ISSUE DATE:

**6 September 2016**

PAGE:

**10 of 65**

THE LEGAL VALIDITY OF THIS REPORT CAN ONLY BE CLAIMED ON PRESENTATION OF THE COMPLETE SIGNED PAPER REPORT. EXTRACTS OR ABRIDGMENTS OF THIS REPORT SHALL NOT BE PUBLISHED WITHOUT PERMISSION FROM BRANZ LTD.

# 1. TEST PROCEDURE

The test was conducted in accordance with AS 1530.4-2005 “Methods for fire tests on building materials, components and structures, Part 4 Fire-resistance tests of elements of construction”, Section 10 Service penetrations and control joints, with reference to AS 4072.1-2005, Service penetrations and control joints, Section 3.1 Fire Resistance Testing.

In accordance with the test standard the fire resistance of the specimen is the time, expressed in minutes, to failure under one or more of the following criteria.

## 1.1 Integrity

Failure shall be deemed to occur when cracks, fissures or other openings develop through which flames or hot gases can pass. Failure occurs;

- a) If flaming on the unexposed surface of the specimen is sustained for longer than 10 seconds; or
- b) When flames and/or hot gases cause flaming or glowing of the cotton fibre pad.

## 1.2 Insulation

Failure shall be deemed to occur when any of the relevant thermocouples attached to the unexposed face of the test specimen rises more than 180K above the initial temperature.

# 2. DESCRIPTION OF TEST SPECIMEN

## 2.1 General

The horizontal concrete slab covering the 4,000 mm x 3,000 mm furnace was nominally 150 mm thick with a density of 2,068 kg/m<sup>3</sup> with a moisture content of 5%.

## 2.2 Penetration details

### 2.2.1 Pipe support spacing

All pipes which were approximately 2,000 mm in length on the upper unexposed side were supported at nominal heights of 500 and 1,500 mm with pipe clamps which were in turn attached to a steel frame.

### 2.2.2 Pipe specification

Table 1 lists the nominal and measured pipe dimensions and pipe designation details for the pipe penetrations.

For specimen No. 20 no pipe was fitted in the penetration. A cast in collar was used and the underside of the hole was blanked with a 0.4 mm galvanised steel plate and the hole filled with concrete flush to the upper surface.



REPORT NUMBER:

**FR 5670**

ISSUE DATE:

**6 September 2016**

PAGE:

**11 of 65**

PCRC

ES

**Table 1: Specimen pipe details**

Specimen #	Pipe Size (Nom mm)	Core Hole Size (mm)	Pipe type	Pipe dimensions OD/thickness as measured (mm)		Pipe unexposed end	Pipe exposed end
				OD	thk	Open stack/floorwaste	Capped/P-trap
1	80	87	PVC	83.2	3	Floorwaste	P-trap*
2	100	N/A	PVC-SC	110	3.1	Floorwaste	P-trap*§
3	50	N/A	BEP	55.6	2.3	Floorwaste	P-trap*§
4	160	N/A	BEP PVC-U-SC	160	4.2	Stack	Capped
5	160	N/A	HDPE	160	6.5	Stack	Superwool plug
6	160	N/A	Raupiano	161	4.45	Stack	Superwool plug
7	110	N/A	BEP PVC-U-SC	110	3.3	Stack	Capped
8	125	N/A	HDPE	124	5.4	Stack	Capped
9	100	N/A	Raupiano	110	3.2	stack	Superwool plug
10	16	20	Pex-a	16.2	2.6	Stack	Superwool plug
11	20	24	Pex-a	20.2	3.2	Stack	Superwool plug
12	25	26	Pex-a	25.2	3.8	Stack	Superwool plug
13	16	20	Pex-b	16	2.2	Stack	Superwool plug
14	20	24	Pex-b	20	2.4	Stack	Superwool plug
15	25	26	Pex-b	25	2.7	Stack	Superwool plug
16	16	N/A	Pex-a	16.1	2.6	Stack	Superwool plug
17	16	N/A	Pex-b	16	2.1	Stack	Superwool plug
18	20	N/A	Pex-a	20	2.2	Stack	Superwool plug
19	20	N/A	Pex-b	20.2	2.3	Stack	Superwool plug
20	110	N/A	Blank, 0.4 mm galv steel plate				
22	110	N/A	BEP PVC-U-SC	110	3.3	Floorwaste	P-trap*



REPORT NUMBER:

**FR 5670**

ISSUE DATE:

**6 September 2016**

PAGE:

**12 of 65**



THE LEGAL VALIDITY OF THIS REPORT CAN ONLY BE CLAIMED ON PRESENTATION OF THE COMPLETE SIGNED PAPER REPORT. EXTRACTS OR ABRIDGMENTS OF THIS REPORT SHALL NOT BE PUBLISHED WITHOUT PERMISSION FROM BRANZ LTD.

Specimen #	Pipe Size (Nom mm)	Core Hole Size (mm)	Pipe type	Pipe dimensions OD/thickness as measured (mm)		Pipe unexposed end	Pipe exposed end
23	65	N/A	PVC-U	68.8	2.9	Stack	Superwool plug
24	40	N/A	PVC-U	43	2.5	Stack	Superwool plug
26	50	N/A	HDPE	40.3	3.5	Floorwaste	P-trap*
27	40	47	BEP	43	2.2	Floorwaste	P-trap*
28	40	N/A	HDPE	40	3.3	Stack	Superwool plug
29	32	N/A	Pressure PVC	42.4	2.5	Stack	Superwool plug

\*P-trap filled with water.

§ Acoustic lagging wrapped around pipe up to base of the collar.

### 2.2.3 Penetration seal details

The pipe collar details are presented in Table 2. The sealant used where specified was Fullers Firesound a fire rated acoustic sealant grey in colour.

#### 2.2.3.1 Cast in collars

For specimens' No. 2 to 9, 16 to 26, 28 and 29 the penetration seals were cast into the concrete slab at the time of pouring. Drawings of the six designs of collar are presented in Figure 1 to Figure 6 covering the pipe sizes ranging from 50 mm to 160 mm.

The cast in collars consist of a moulded plastic body with an overall height of 250 mm. The plastic bodies were mounted flush with the underside of the slab then grouted in place. The portions of the bodies that protruded above the slab were then cut to height of the floor slab before installation of the pipes or floor waste fittings. In the cases where floor waste fittings were fitted these were raised from the floor and mounted in in 35 mm of screed/mortar comprising 6 parts of sand and 1 part of Golden Bay cement.

The nominal dimensions of the intumescent strips fitted to the collars are shown in Figure 1 to Figure 6 and Table 2 shows the measured sizes of the intumescent strips.



REPORT NUMBER:

**FR 5670**

ISSUE DATE:

**6 September 2016**

PAGE:

**13 of 65**



**Figure 1: H100FWS-RR collar (specimens 2, 20 to 22 and 25)**

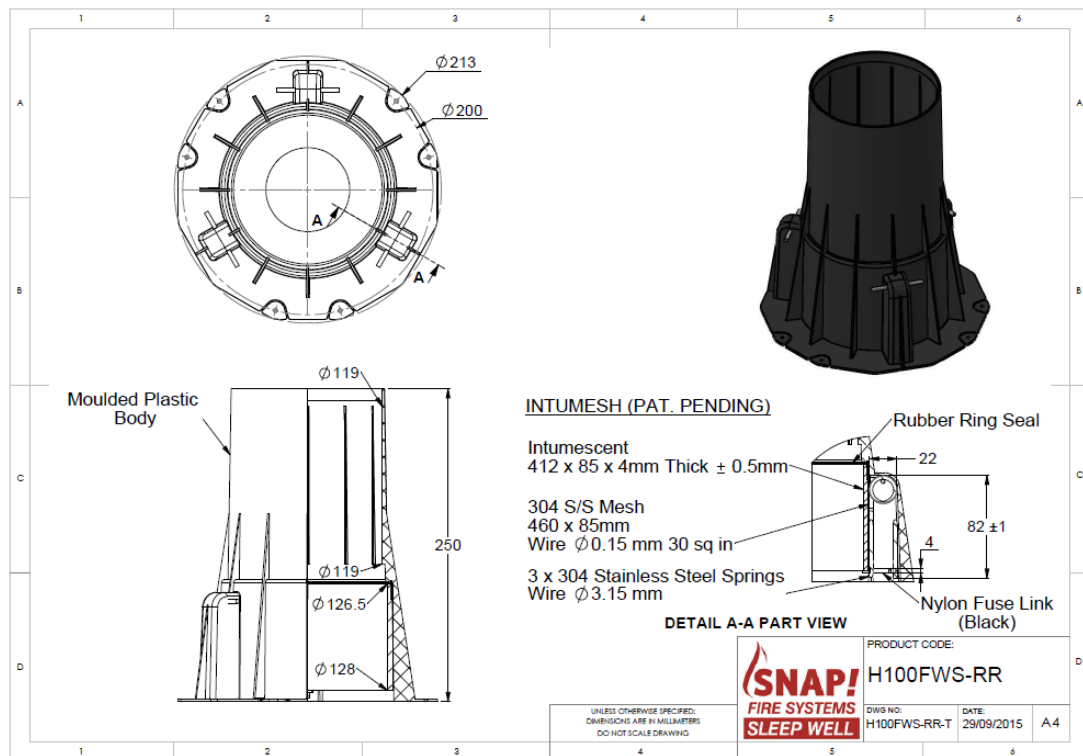

**Figure 2: H50FWS-RR (specimens 3 and 26)**

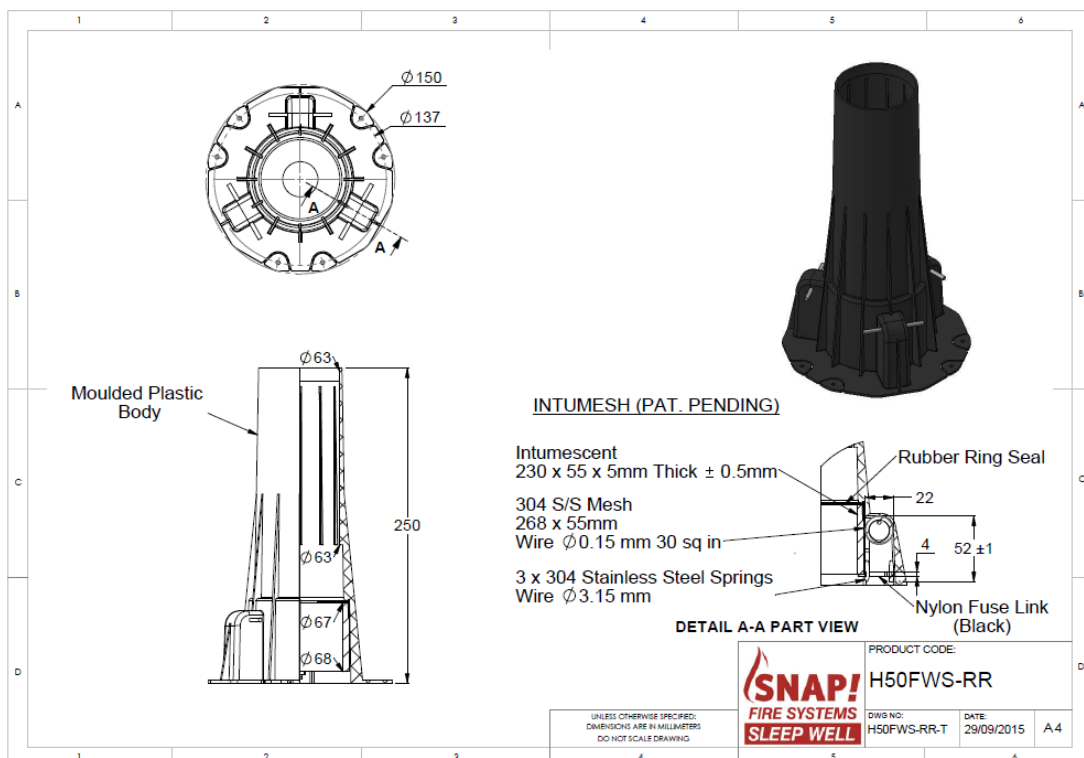

**Figure 3: H50S-RR collar (specimens 16 to 19, 24 and 29)**

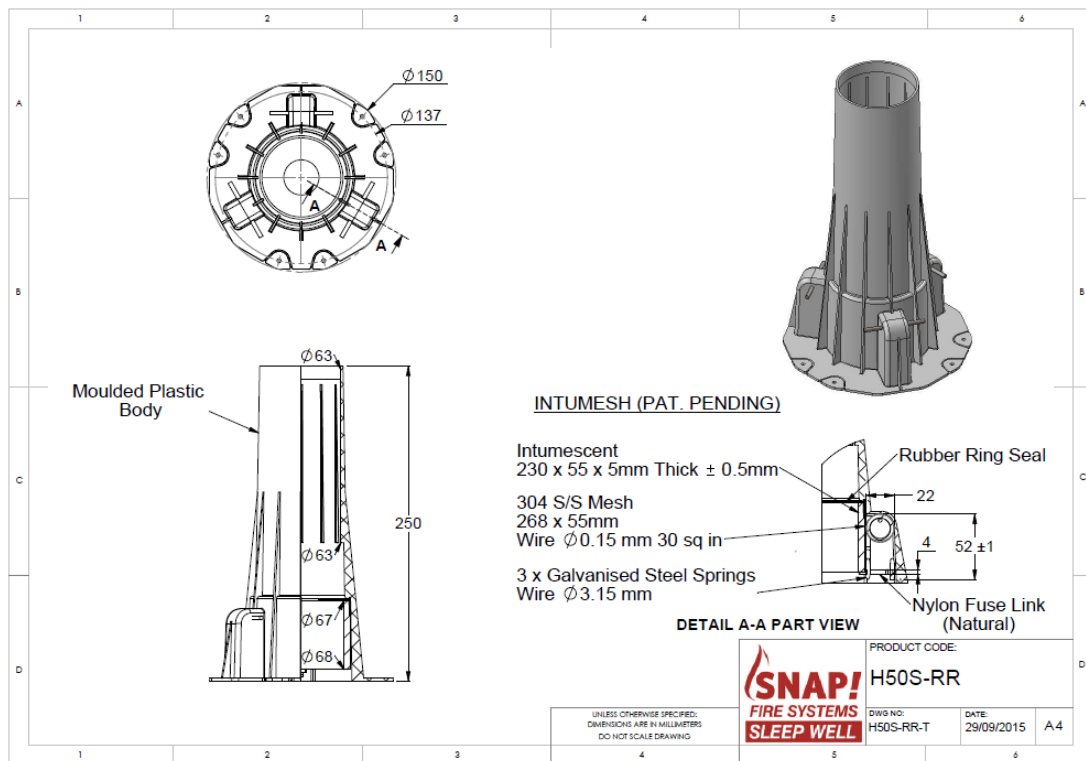

**Figure 4: H65S-RR collar (specimen 28)**

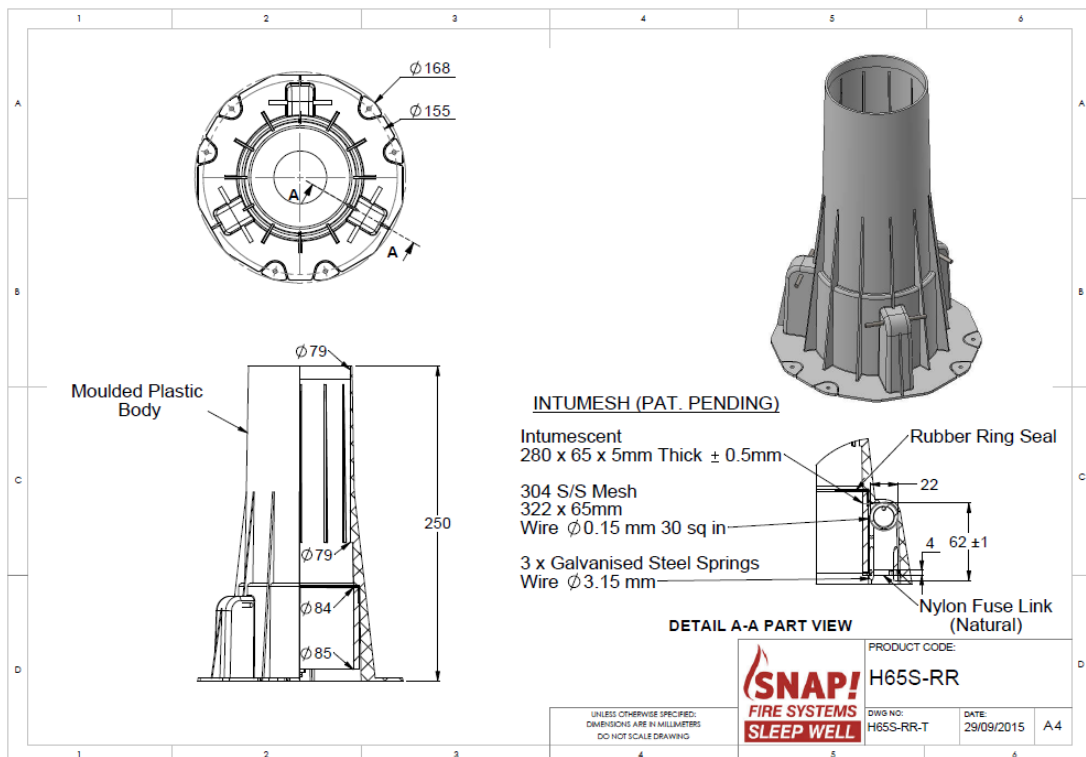

REPORT NUMBER:

**FR 5670**

ISSUE DATE:

**6 September 2016**

PAGE:

**15 of 65**

PCRC

ES

THE LEGAL VALIDITY OF THIS REPORT CAN ONLY BE CLAIMED ON PRESENTATION OF THE COMPLETE SIGNED PAPER REPORT. EXTRACTS OR ABRIDGMENTS OF THIS REPORT SHALL NOT BE PUBLISHED WITHOUT PERMISSION FROM BRANZ LTD.

Figure 5: H150 S-RR collar (specimens 4 to 9)

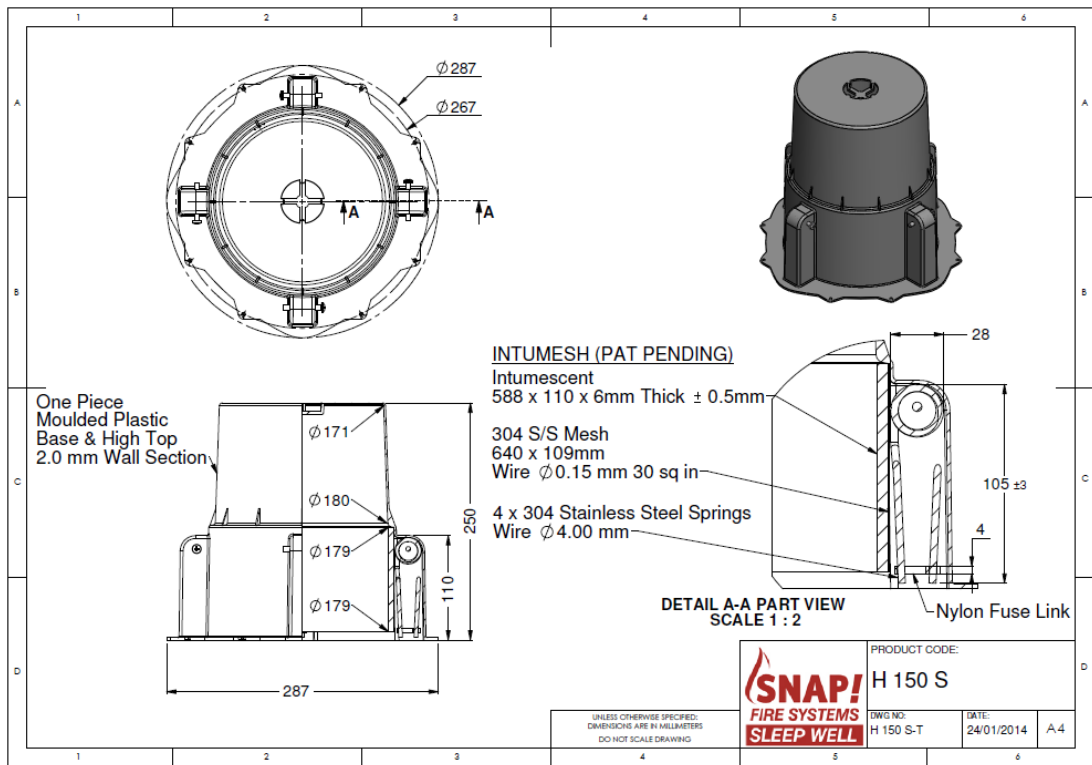
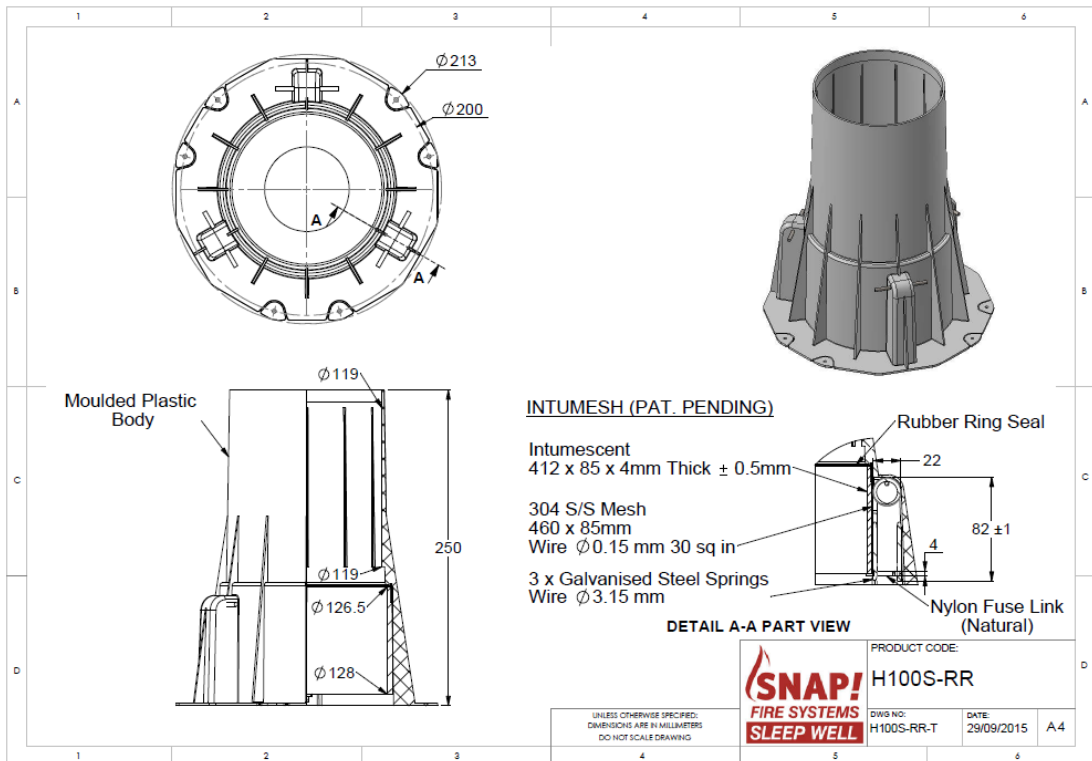

Figure 6: H100S-RR (specimen 23)



REPORT NUMBER:

FR 5670

ISSUE DATE:

6 September 2016

PAGE:

16 of 65

PCRC

ES

THE LEGAL VALIDITY OF THIS REPORT CAN ONLY BE CLAIMED ON PRESENTATION OF THE COMPLETE SIGNED PAPER REPORT. EXTRACTS OR ABRIDGMENTS OF THIS REPORT SHALL NOT BE PUBLISHED WITHOUT PERMISSION FROM BRANZ LTD.



### 2.2.3.2 Retrofit collars

For specimens' No. 1, 10 to 15 and 27 holes were drilled in the concrete and collars fitted on the underside.

Drawings of the three designs of collar are presented in Figure 7 to Figure 9 covering the pipe sizes ranging from 16 mm to 80 mm.

The nominal dimensions of the intumescent strips fitted to the collars are shown in Figure 7 to Figure 9 and Table 2 shows the measured sizes of the intumescent strips that were tested in FR 5670.

**Figure 7: LP100R-C (specimen 1)**

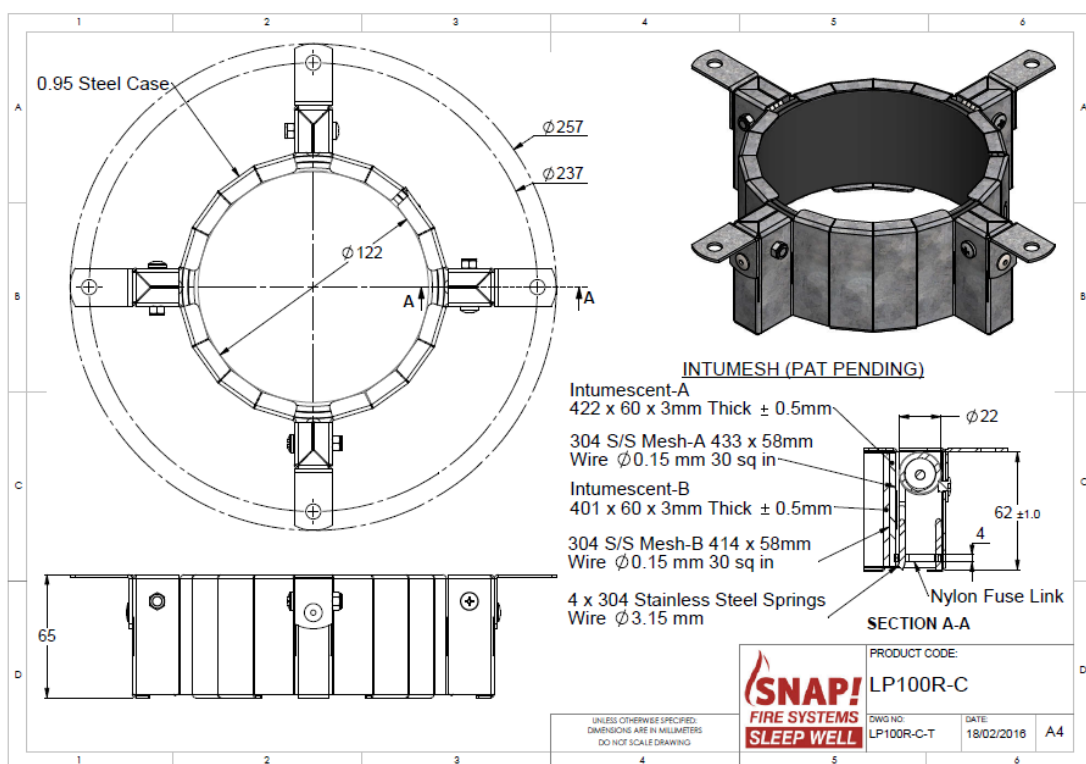

REPORT NUMBER:

**FR 5670**

ISSUE DATE:

**6 September 2016**

PAGE:

**17 of 65**

PCRC

ES

**Figure 8: 32R collar (specimens 10 to 15)**

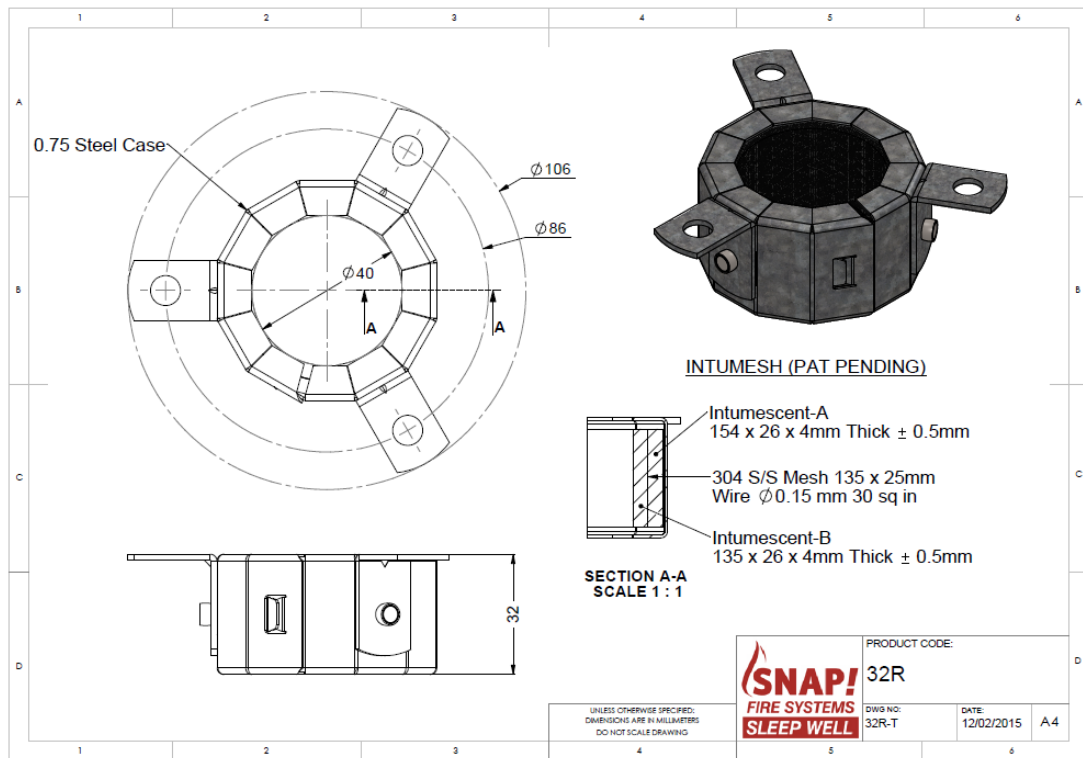

**Figure 9: LP50R (specimen 27)**

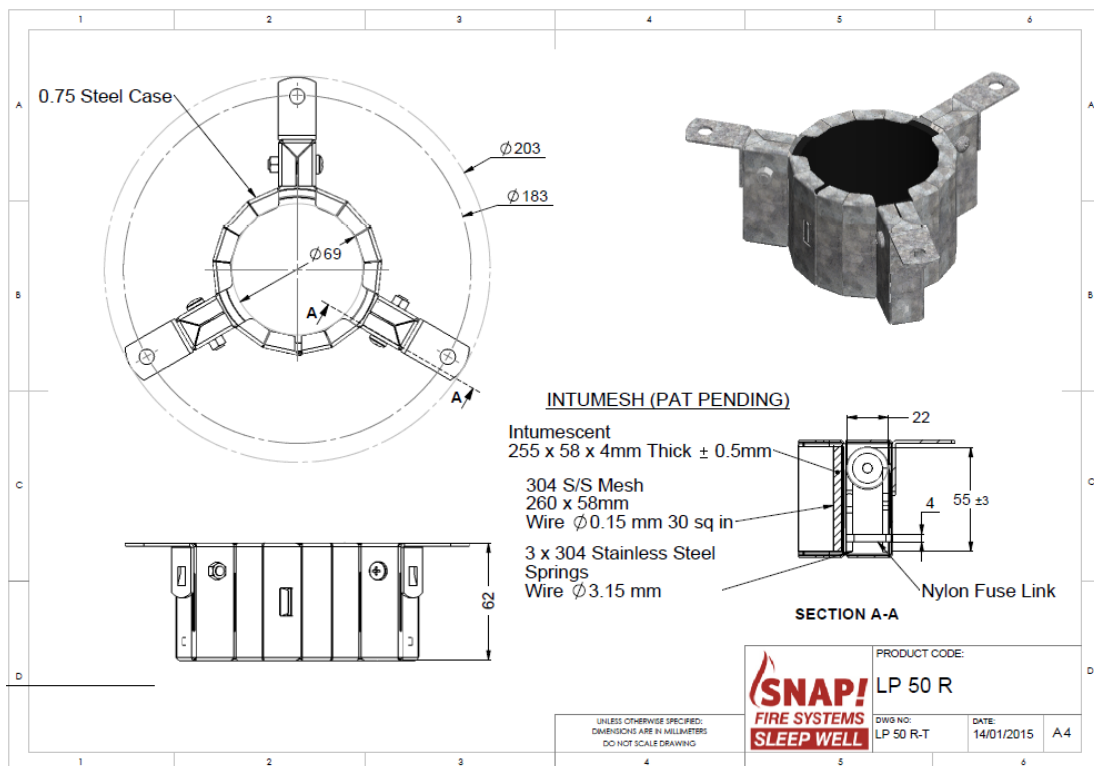

**Table 2: Pipe collars**

Specimen #	Pipe Size (Nom mm)	Product Code	Intumescent Material, WidthxThick	Cast in or Retrofit	Sealing on unexposed side
1	80	LP100R-C	2 x 2.5 x 60 + 4 springs	Retro-Fit	35 mm Screed, top of grate flush
2	100	H100FWS-RR	1 x 3.8 x 90 + 3 springs	Cast-in	36 mm Screed, top of grate flush
3	50	H50FWS-RR	1 x 4.8 x 56 + 3 springs	Cast-in	37 mm Screed, top of grate flush
4	160	H150S-RR	1 x 6 x 110 + 3 springs	Cast-in	Grout/mortar seal around pipe to depth of 30mm
5	160	H150S-RR	1 x 6 x 110 + 3 springs	Cast-in	Grout/mortar seal around pipe to depth of 30mm
6	160	H150S-RR	1 x 6 x 110 + 3 springs	Cast-in	Bead of Fullers Firesound sealant as seal
7	110	H150S-RR	1 x 6 x 110 + 3 springs	Cast-in	Grout/mortar seal to 30mm depth
8	125	H150S-RR	1 x 6 x 110 + 3 springs	Cast-in	Grout/mortar seal to 30mm depth
9	100	H150S-RR	1 x 6 x 110 + 3 springs	Cast-in	Grout/mortar to within 10mm of pipe, then Fullers Firesound sealant for final 10mm
10	16	32R	2 x 4.1 x 25	Retro-Fit	Grout/Mortar seal
11	20	32R	2 x 4.1 x 25	Retro-Fit	Grout/Mortar seal
12	25	32R	2 x 4.1 x 25	Retro-Fit	Grout/Mortar seal
13	16	32R	2 x 4.1 x 25	Retro-Fit	Grout/Mortar seal
14	20	32R	2 x 4.1 x 25	Retro-Fit	Grout/Mortar seal
15	25	32R	2 x 4.1 x 25	Retro-Fit	Grout/Mortar seal
16	16	H50S-RR	1 x 4.8 x 56 + 3 springs	Cast-in	Backfilled with mortar/grout to 30-40mm
17	16	H50S-RR	1 x 4.8 x 56 + 3 springs	Cast-in	Backfilled with mortar/grout to 30-40mm
18	20	H50S-RR	1 x 4.8 x 56 + 3 springs	Cast-in	Backfilled with mortar/grout to 30-40mm
19	20	H50S-RR	1 x 4.8 x 56 + 3 springs	Cast-in	Backfilled with mortar/grout to 30-40mm
20	110	H100FWS-RR	1 x 3.8 x 90 + 3 springs	Cast-in	Backfilled with grout/mortar to finish flush with surface of slab



REPORT NUMBER:

**FR 5670**

ISSUE DATE:

**6 September 2016**

PAGE:

**19 of 65**



Specimen #	Pipe Size (Nom mm)	Product Code	Intumescent Material, WidthxThick	Cast in or Retrofit	Sealing on unexposed side
22	110	H100FWS-RR	1 x 3.8 x 90 + 3 springs	Cast-in	35mm screed, top of grate flush
23	65	H100S-RR	1 x 3.8 x 90 + 3 springs	Cast-in	No Seal around pipe
24	40	H50S-RR	1 x 4 x 53	Cast-in	No Seal around pipe
26	40	H50FWS-RR	1 x 4.8 x 56	Cast-in	35mm Screed, top of grate flush
27	40	LP50R	1 x 4 x 60 + 3 springs	Retro-Fit	35mm Screed, top of grate flush
28	40	H65S-RR	1 x 4.2 x 64	Cast-in	Grout/mortar seal to 30 – 40mm depth
29	32	H50S-RR	1 x 4 x 53	Cast-in	Bead of Fullers Firesound to fill Gap



REPORT NUMBER:

**FR 5670**

ISSUE DATE:

**6 September 2016**

PAGE:

**20 of 65**



**Figure 10: Test specimen showing location of penetrations**

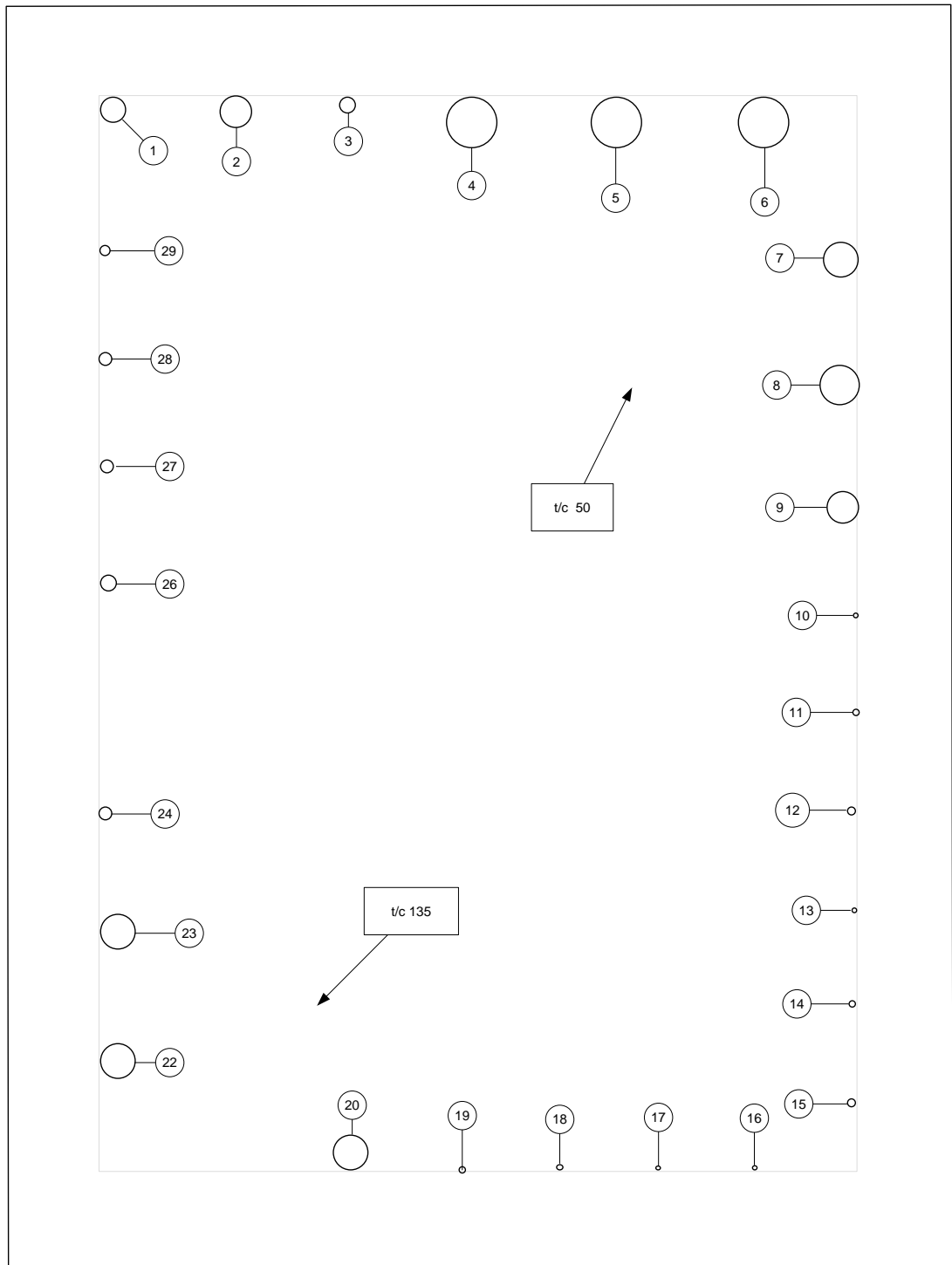

### 3. TEST CONDITIONS AND RESULTS

#### 3.1 General

The specimen was tested on the 3 March 2016 at BRANZ laboratories, Judgeford, New Zealand, in the presence of a representative of the client.

The ambient temperature at the beginning of the test was 16°C.

The wall containing the specimens was placed against the vertical pilot furnace and the temperature and pressure conditions were controlled to the limits defined in AS 1530.4-2005.

#### 3.2 Furnace temperature measurement

Temperature measurement within the furnace was made using twelve mineral insulated metal sheathed (MIMS) chromel-alumel thermocouples uniformly distributed in a vertical plane approximately 100 mm from the exposed face of the specimen.

The furnace thermocouples were connected to a computer controlled data acquisition system which recorded the temperatures at 15 second intervals.

Figure 11 shows the furnace temperature curve and the permitted upper and lower limits in accordance with AS 1530.4: 2005.

**Figure 11: Furnace Temperature**

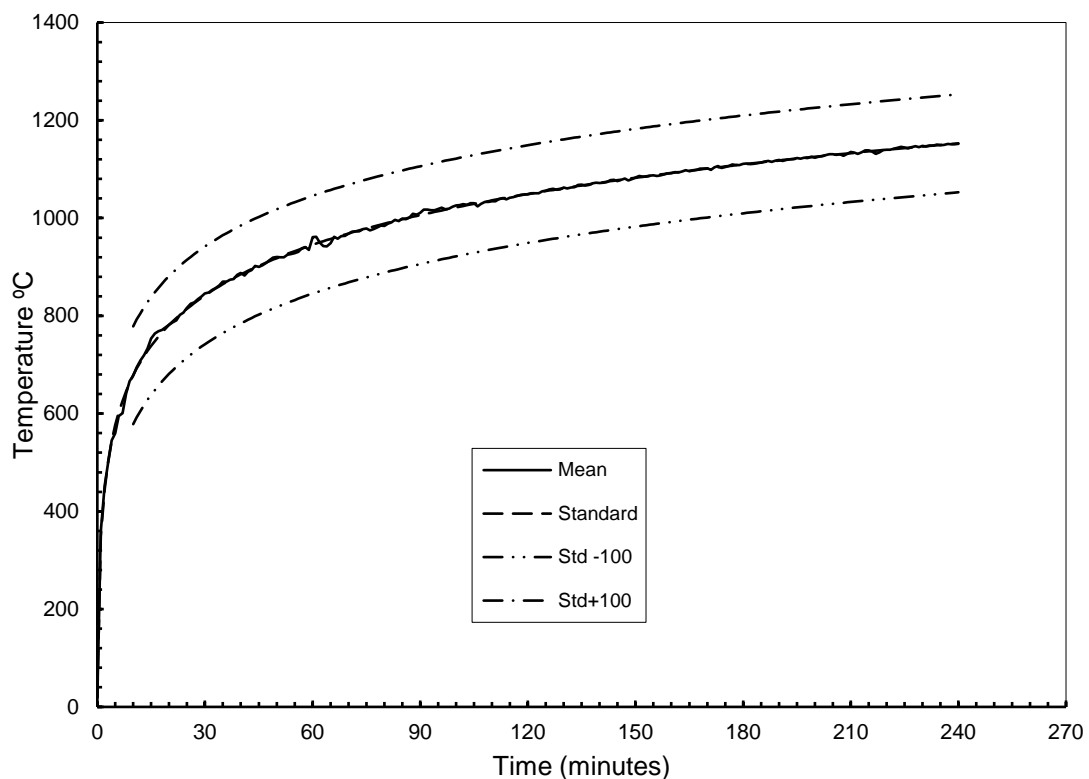

REPORT NUMBER:

**FR 5670**

ISSUE DATE:

**6 September 2016**

PAGE:

**22 of 65**

PCRC

ES

### 3.3 Furnace control

The percentage deviation of the area of the furnace mean temperature from the standard temperature/time curve complied with the test standard for the duration of the test.

Figure 12 shows the percentage deviation of the mean furnace temperature from the Standard curve.

**Figure 12: Deviation of mean furnace temperature**

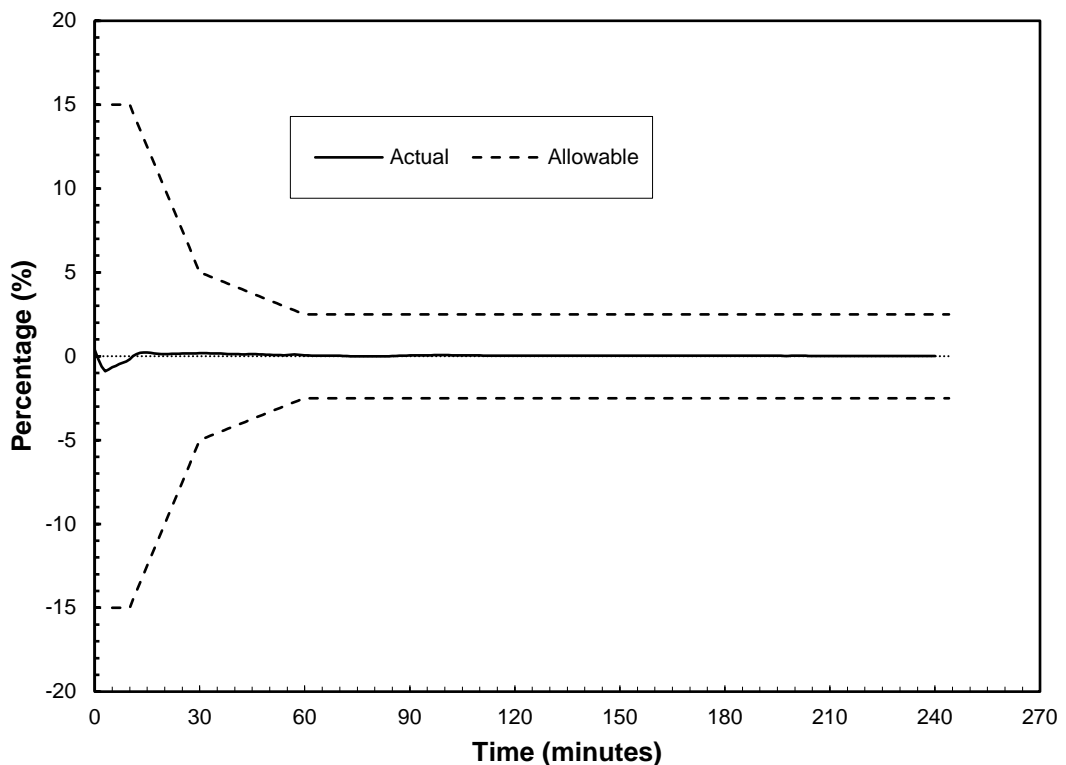

### 3.4 Pressure measurement

The differential pressure was controlled to be 20 Pa at 100 mm below the concrete slab. The differential pressure was monitored using a micro-manometer connected to a computer controlled data acquisition system which recorded the pressure at 15 second intervals.

Figure 13 shows the pressure measured at the probe between the furnace and the frame during the test, where the target pressure was 18.4 Pa.

**Figure 13: Furnace pressure**

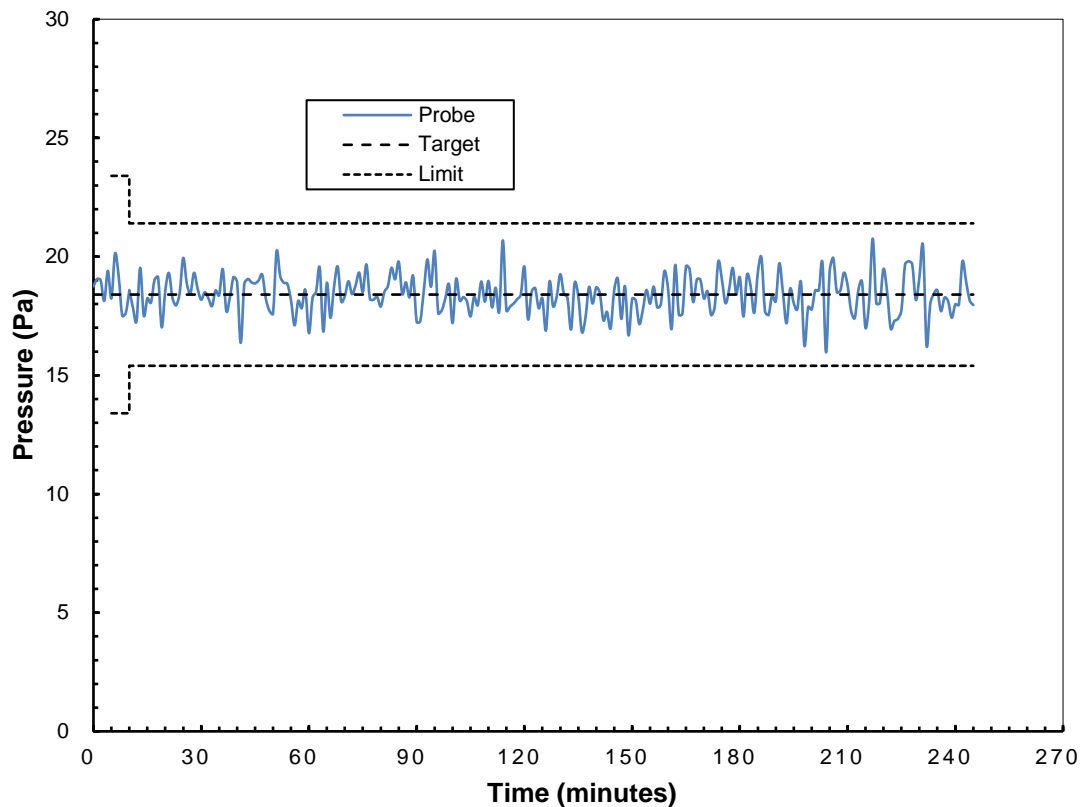

The furnace pressure complied with the test standard for the entirety of the test.

### 3.5 Specimen temperature measurement

The temperature on the unexposed face of the penetrations were measured with chromel-alumel thermocouples attached to the specimens. The arrangement consisted of thermocouples placed as specified in clause 10.5 of the test standard AS 1530.4-2005.

For pipe specimens on the unexposed side, thermocouples were placed on the unexposed surface of the concrete slab at 25 mm from the collar, on the collar and on the pipes at a distance 25 mm from the collar. These three locations were in pairs with thermocouples fitted to the top and side of the penetrations, making a total of six thermocouples per penetration. In cases where sealant was not applied to the pipe/concrete junction it was necessary to place thermocouples down inside the pipe/concrete gap on top of the intumescent.

For the floor waste specimens a thermocouple was placed on top of the grill and two thermocouples on the upper surface of the concrete 25 mm from the grill.

Two additional thermocouples were placed on the unexposed surface of the concrete slab clear of any of the penetrations.



Figure 14 to Figure 40 show the temperature rise for each specimen.

The temperature rise on the unexposed side of the concrete slab is shown in Figure 41 where the positions of thermocouples 50 and 135 are shown in Figure 10.

**Figure 14: Specimen 1 temperature rise**

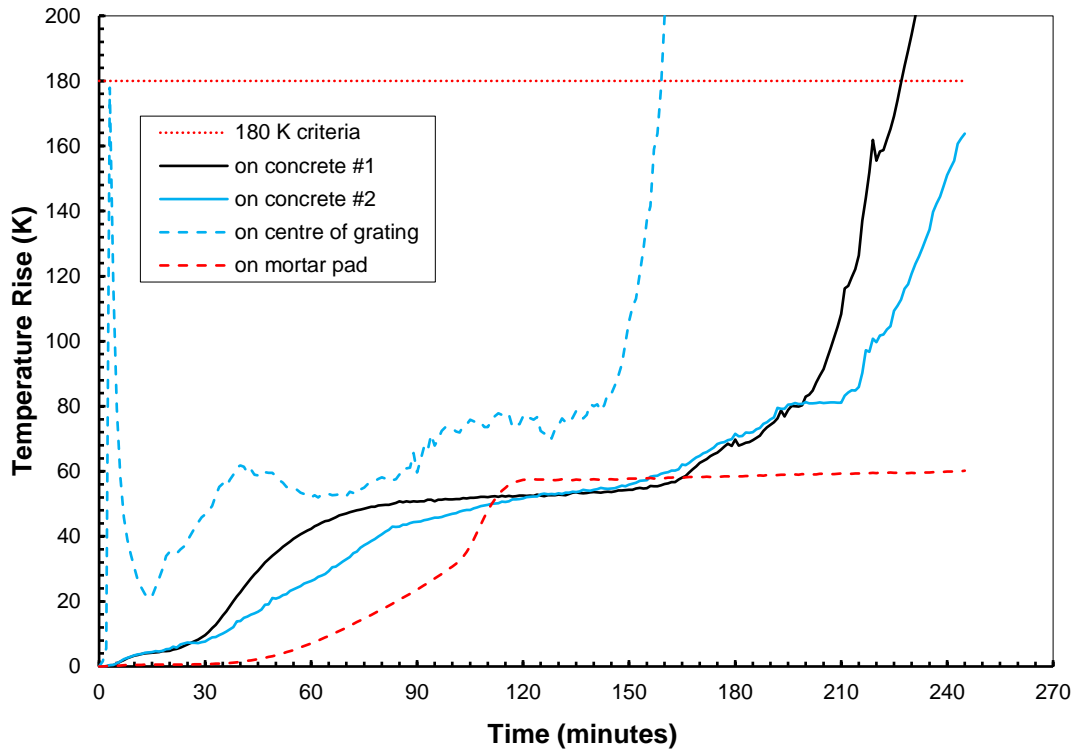

Figure 15: Specimen 2 temperature rise

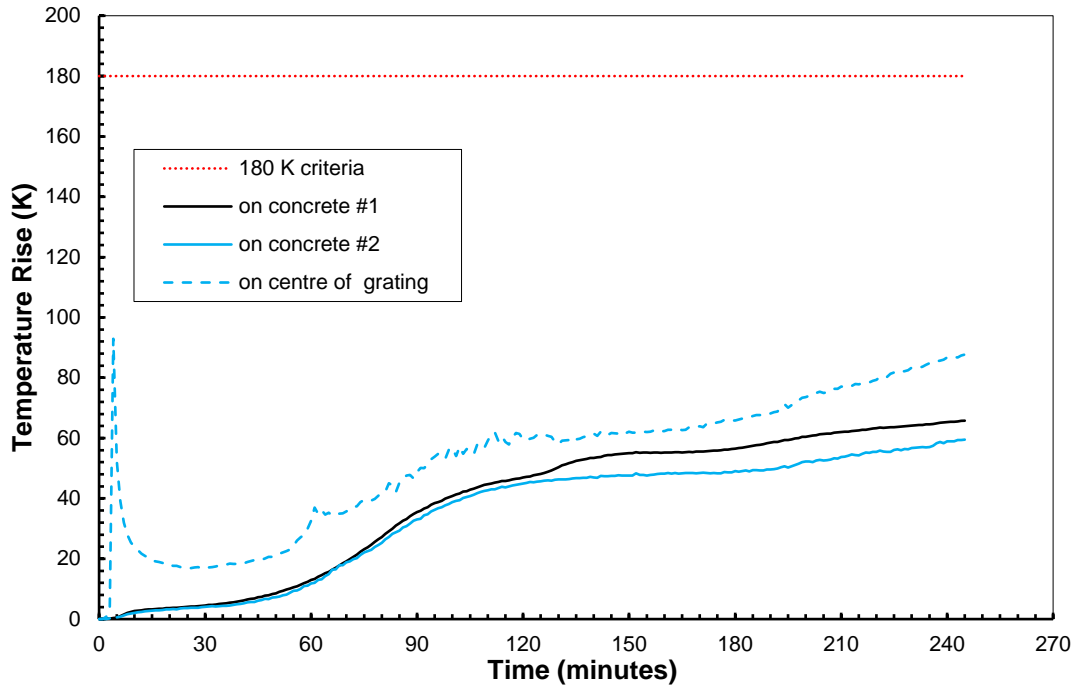
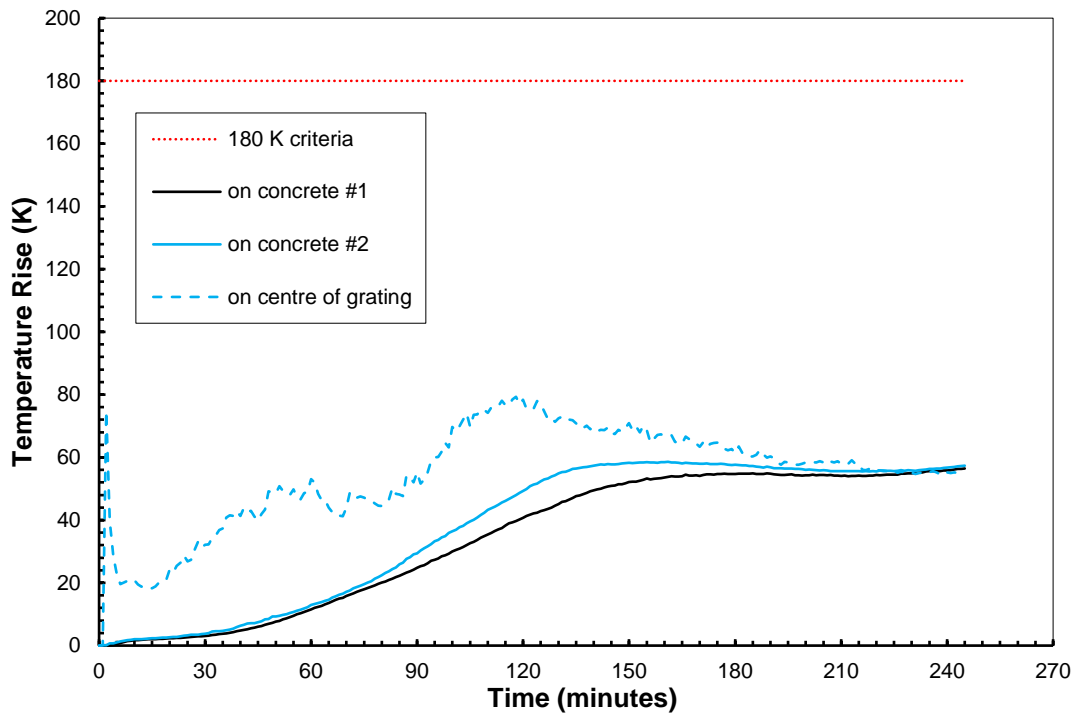

Figure 16: Specimen 3 temperature rise



REPORT NUMBER:

**FR 5670**

ISSUE DATE:

**6 September 2016**

PAGE:

**26 of 65**

PCRC

ES

THE LEGAL VALIDITY OF THIS REPORT CAN ONLY BE CLAIMED ON PRESENTATION OF THE COMPLETE SIGNED PAPER REPORT. EXTRACTS OR ABRIDGMENTS OF THIS REPORT SHALL NOT BE PUBLISHED WITHOUT PERMISSION FROM BRANZ LTD.

Figure 17: Specimen 4 temperature rise

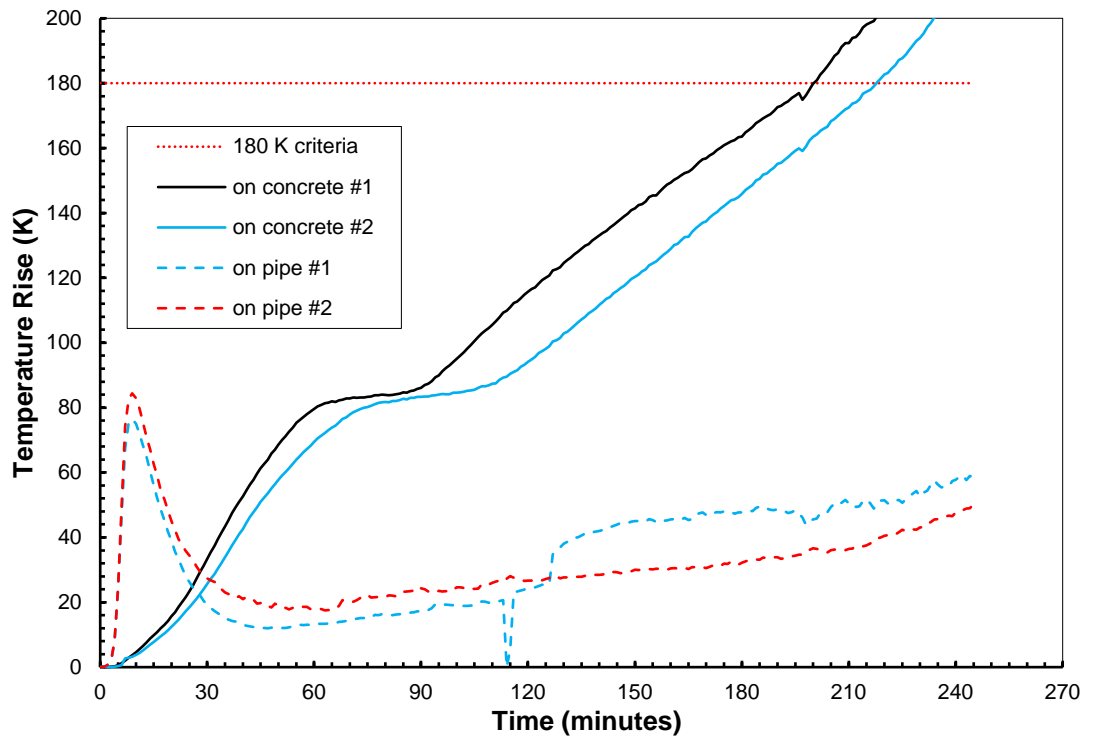
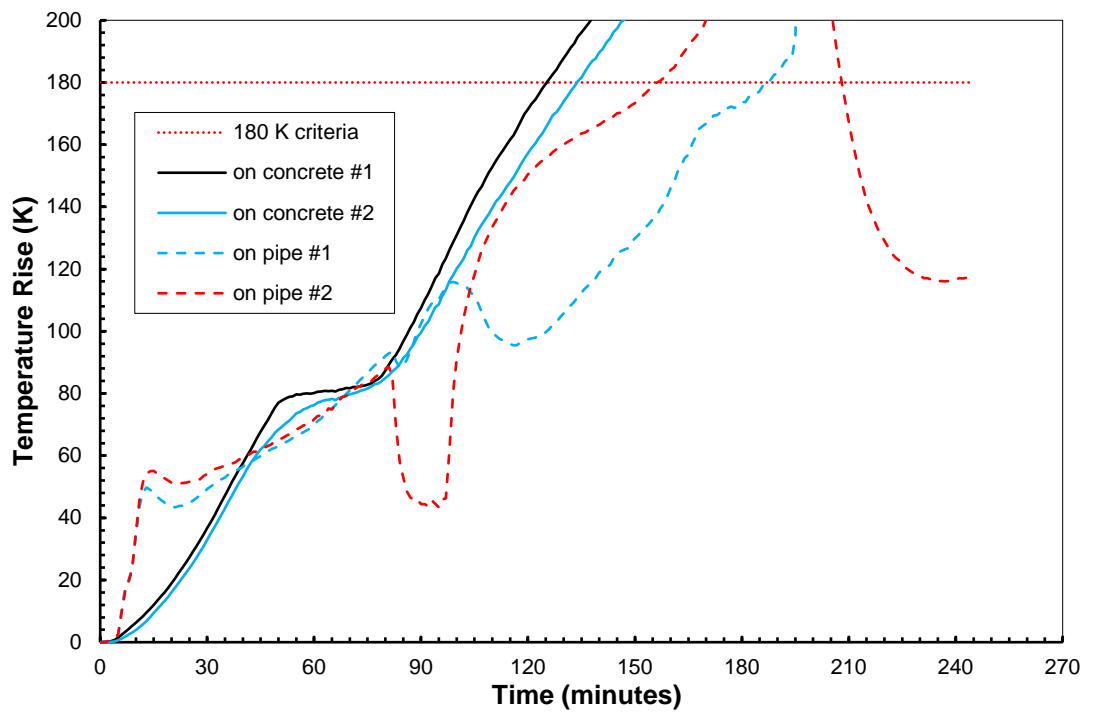

Figure 18: Specimen 5 temperature rise



REPORT NUMBER:

**FR 5670**

ISSUE DATE:

**6 September 2016**

PAGE:

**27 of 65**



THE LEGAL VALIDITY OF THIS REPORT CAN ONLY BE CLAIMED ON PRESENTATION OF THE COMPLETE SIGNED PAPER REPORT. EXTRACTS OR ABRIDGMENTS OF THIS REPORT SHALL NOT BE PUBLISHED WITHOUT PERMISSION FROM BRANZ LTD.

Figure 19: Specimen 6 temperature rise

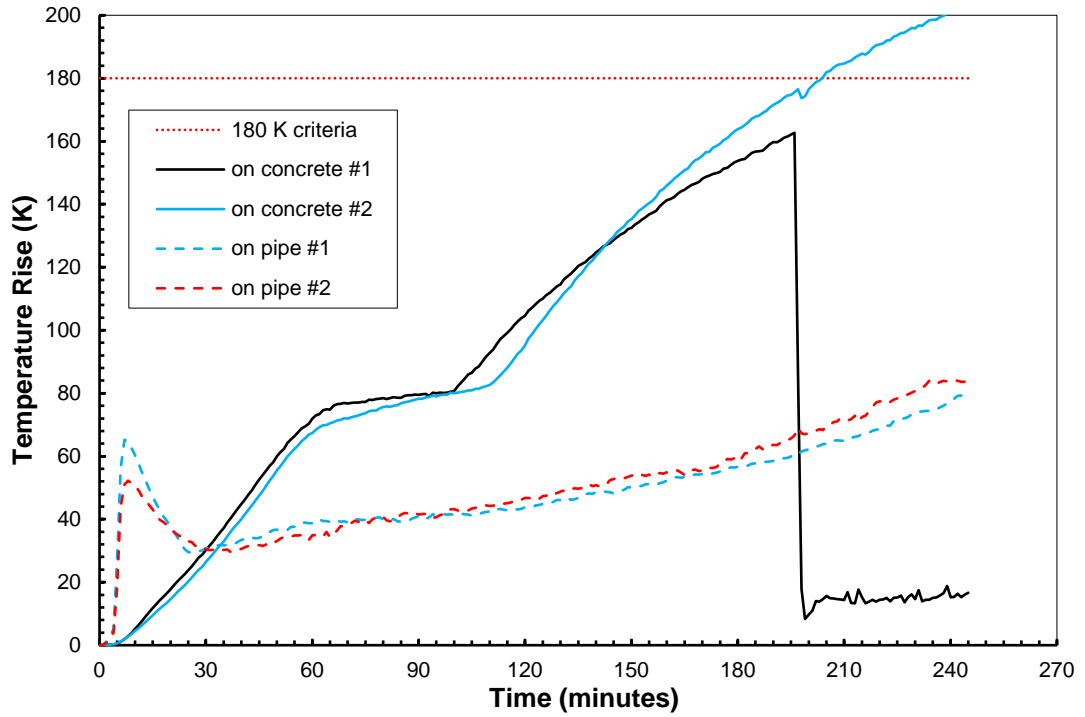
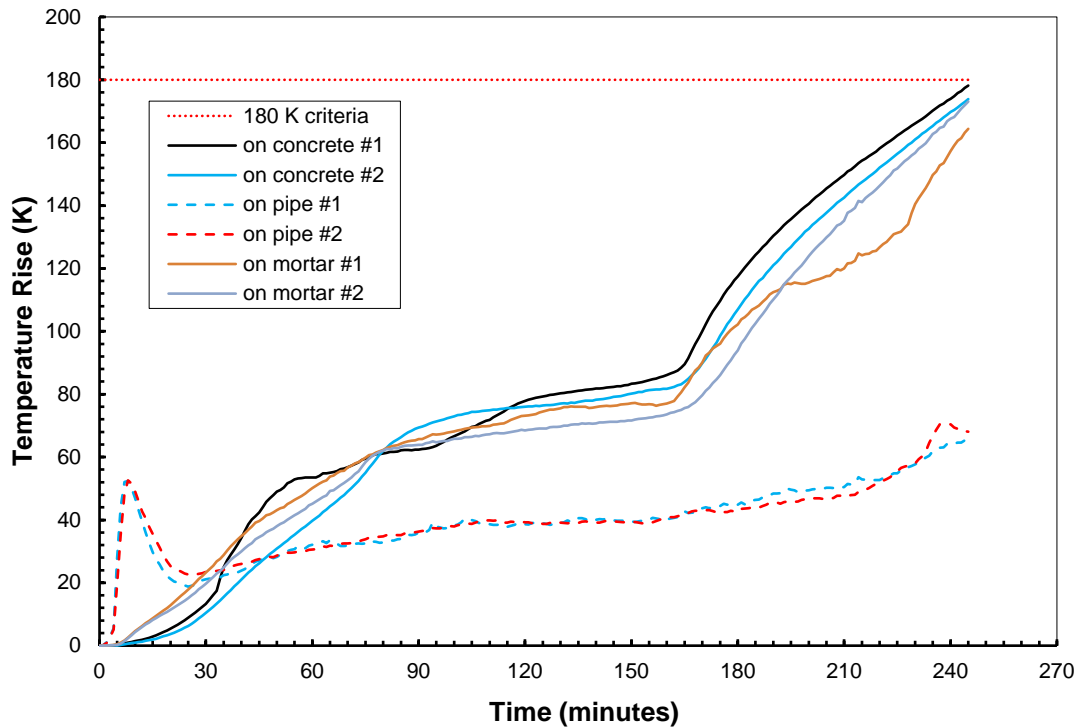

Figure 20: Specimen 7 temperature rise



REPORT NUMBER:

**FR 5670**

ISSUE DATE:

**6 September 2016**

PAGE:

**28 of 65**

PCRC

ES

THE LEGAL VALIDITY OF THIS REPORT CAN ONLY BE CLAIMED ON PRESENTATION OF THE COMPLETE SIGNED PAPER REPORT. EXTRACTS OR ABRIDGMENTS OF THIS REPORT SHALL NOT BE PUBLISHED WITHOUT PERMISSION FROM BRANZ LTD.

Figure 21: Specimen 8 temperature rise

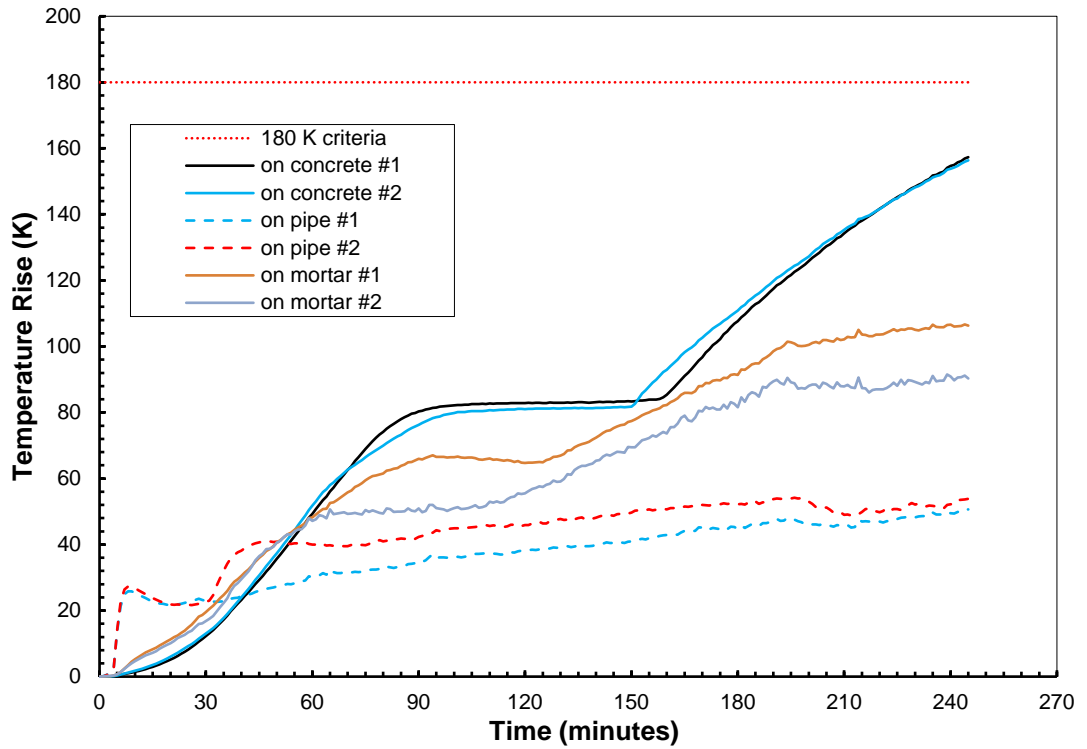
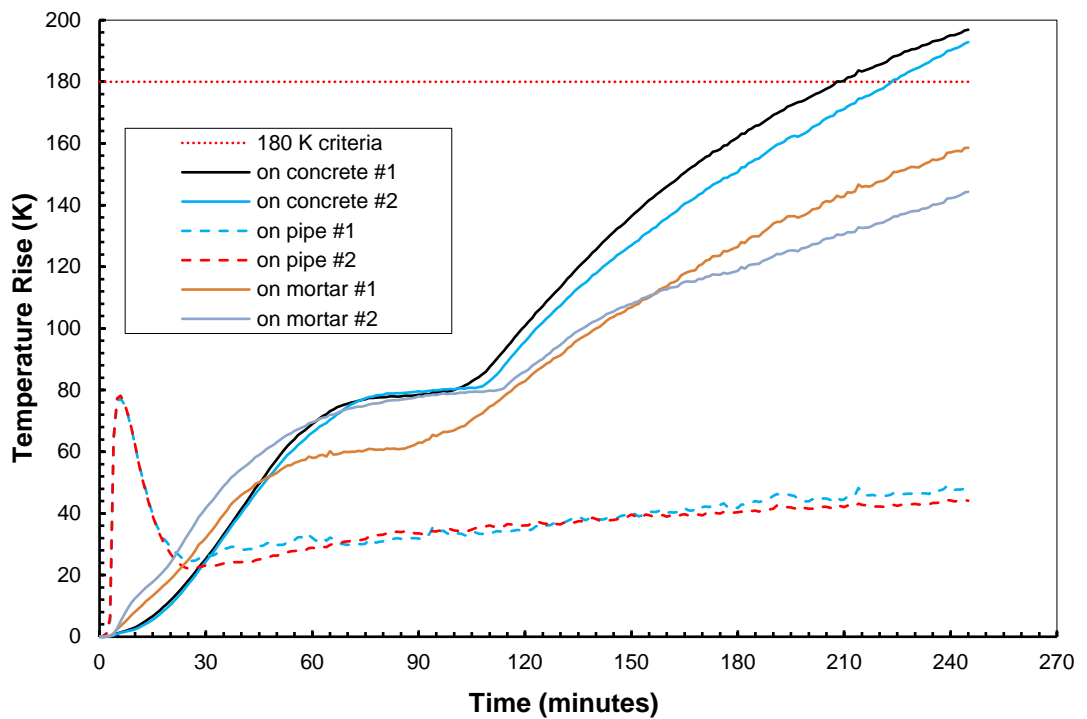

Figure 22: Specimen 9 temperature rise



REPORT NUMBER:

**FR 5670**

ISSUE DATE:

**6 September 2016**

PAGE:

**29 of 65**

PCRC

ES

THE LEGAL VALIDITY OF THIS REPORT CAN ONLY BE CLAIMED ON PRESENTATION OF THE COMPLETE SIGNED PAPER REPORT. EXTRACTS OR ABRIDGMENTS OF THIS REPORT SHALL NOT BE PUBLISHED WITHOUT PERMISSION FROM BRANZ LTD.

**Figure 23: Specimen 10 temperature rise**

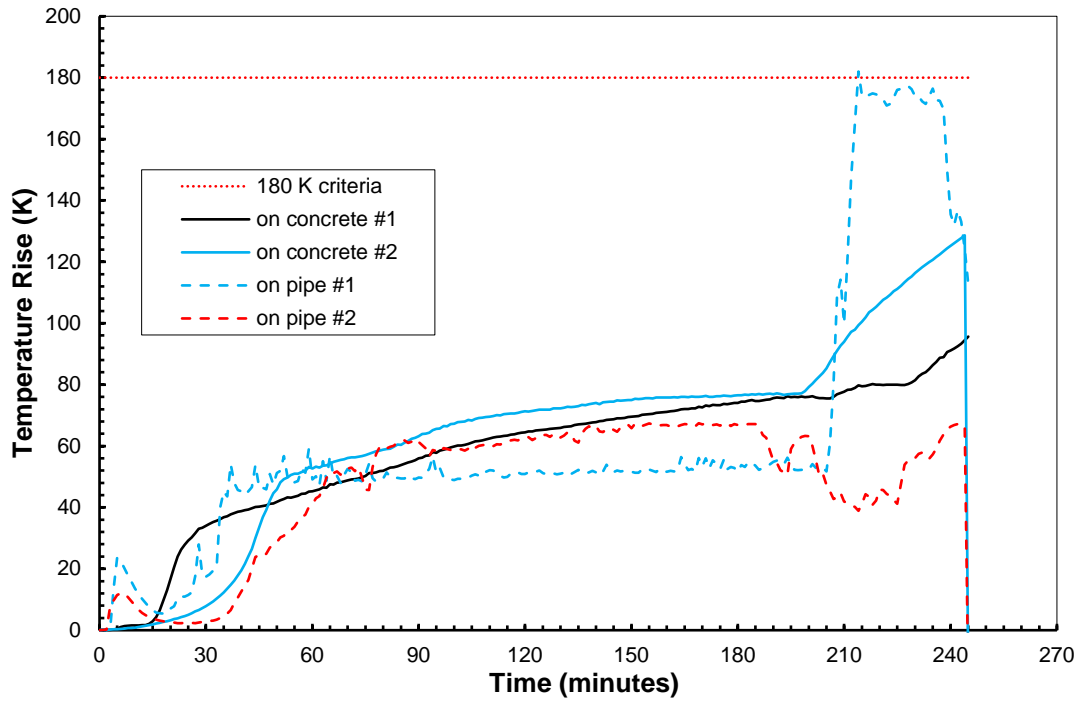

**Figure 24: Specimen 11 temperature rise**

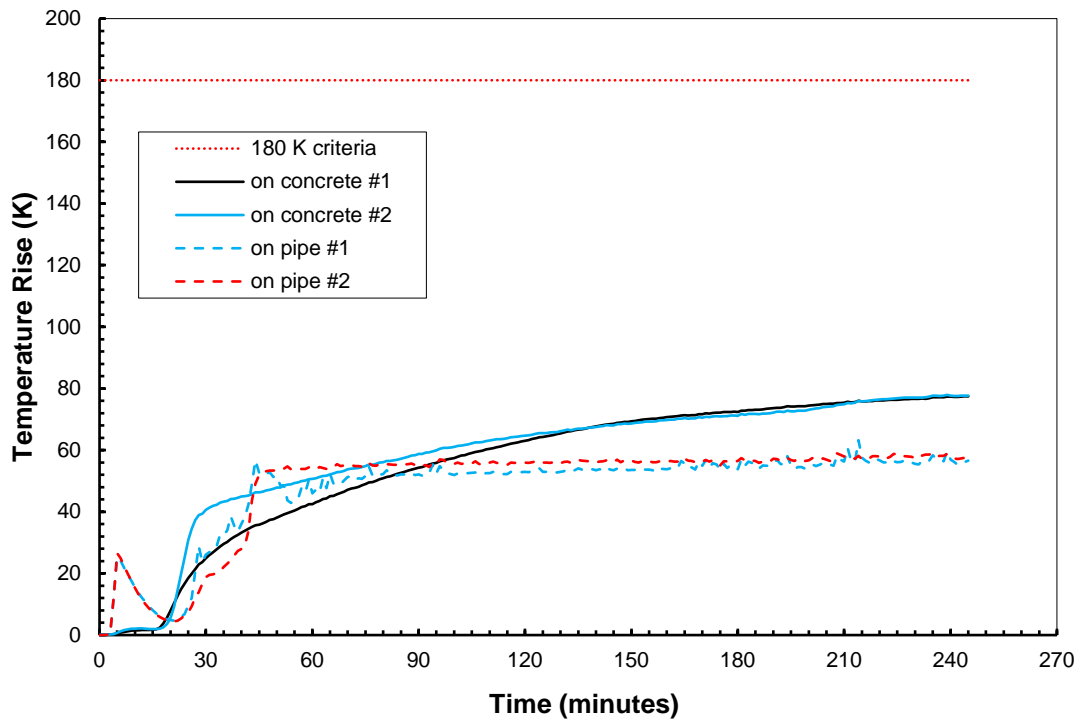

REPORT NUMBER:

**FR 5670**

ISSUE DATE:

**6 September 2016**

PAGE:

**30 of 65**

PCRC

ES

THE LEGAL VALIDITY OF THIS REPORT CAN ONLY BE CLAIMED ON PRESENTATION OF THE COMPLETE SIGNED PAPER REPORT.  
EXTRACTS OR ABRIDGMENTS OF THIS REPORT SHALL NOT BE PUBLISHED WITHOUT PERMISSION FROM BRANZ LTD.

**Figure 25: Specimen 12 temperature rise**

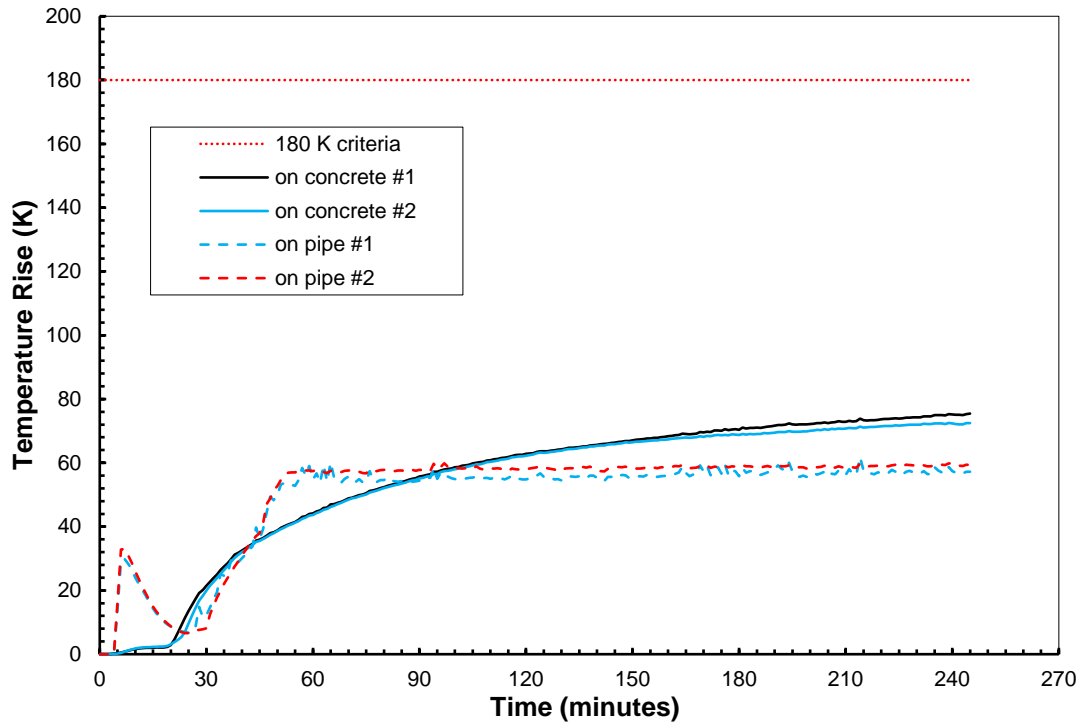

**Figure 26: Specimen 13 temperature rise**

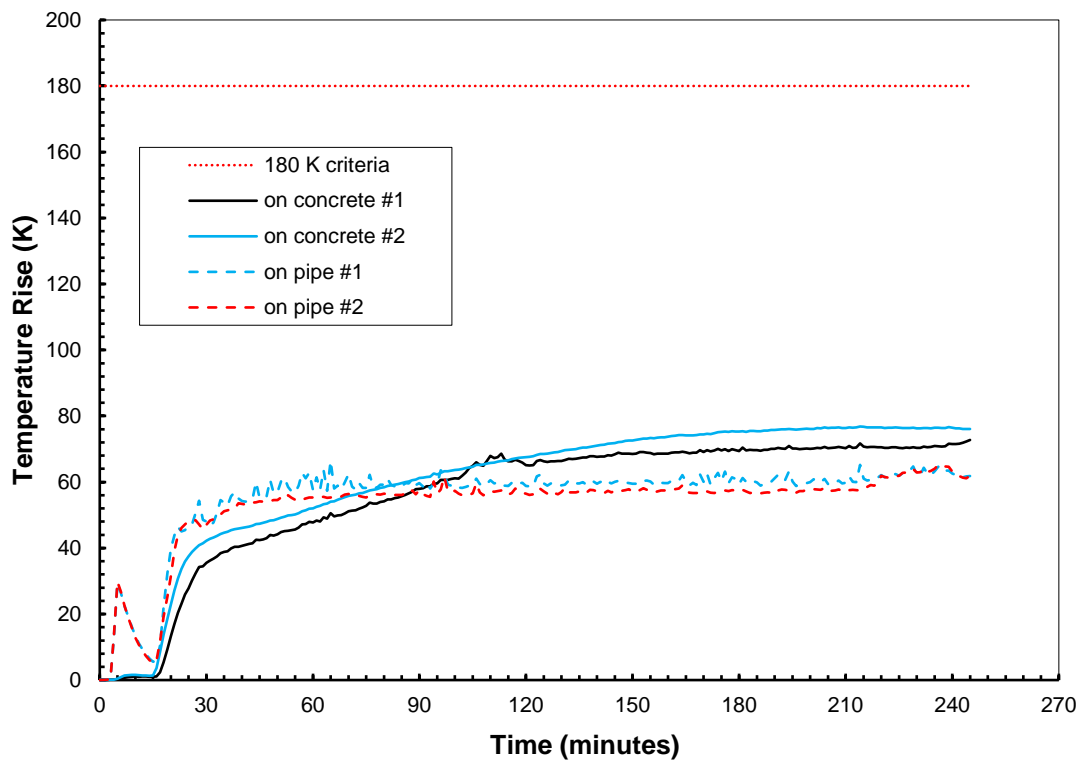

REPORT NUMBER:

**FR 5670**

ISSUE DATE:

**6 September 2016**

PAGE:

**31 of 65**

PCRC

ES

THE LEGAL VALIDITY OF THIS REPORT CAN ONLY BE CLAIMED ON PRESENTATION OF THE COMPLETE SIGNED PAPER REPORT. EXTRACTS OR ABRIDGMENTS OF THIS REPORT SHALL NOT BE PUBLISHED WITHOUT PERMISSION FROM BRANZ LTD.

Figure 27: Specimen 14 temperature rise

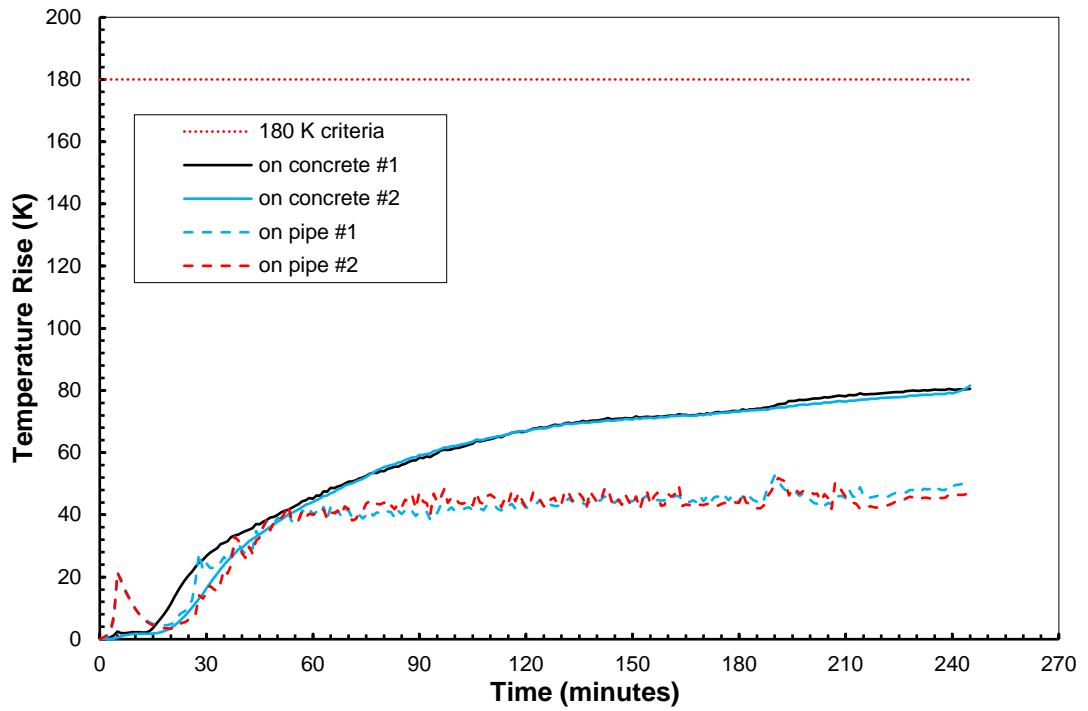
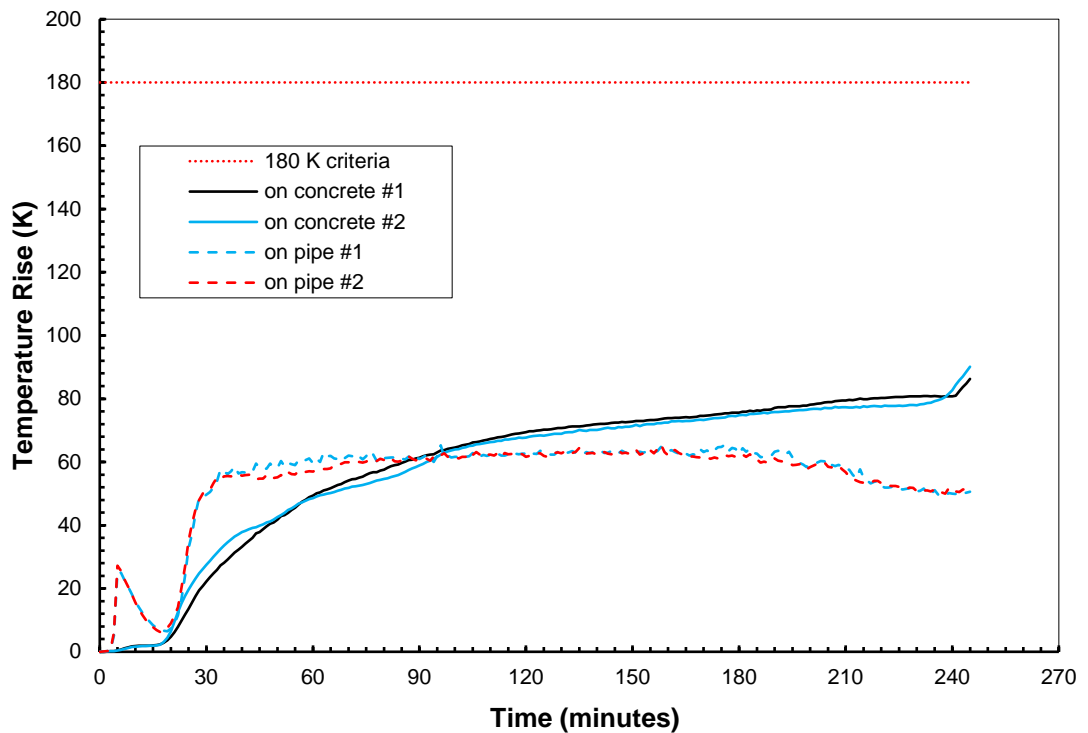

Figure 28: Specimen 15 temperature rise



REPORT NUMBER:

FR 5670

ISSUE DATE:

6 September 2016

PAGE:

32 of 65

PCRC

ES

THE LEGAL VALIDITY OF THIS REPORT CAN ONLY BE CLAIMED ON PRESENTATION OF THE COMPLETE SIGNED PAPER REPORT. EXTRACTS OR ABRIDGMENTS OF THIS REPORT SHALL NOT BE PUBLISHED WITHOUT PERMISSION FROM BRANZ LTD.



**Figure 29: Specimen 16 temperature rise**

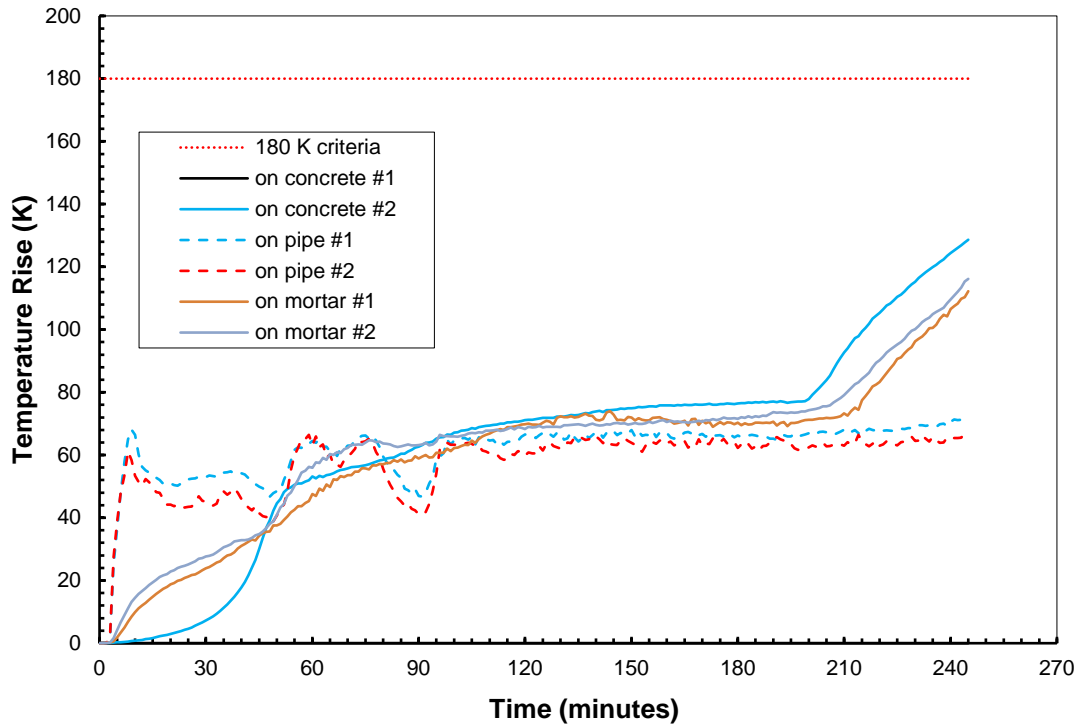

**Figure 30: Specimen 17 temperature rise**

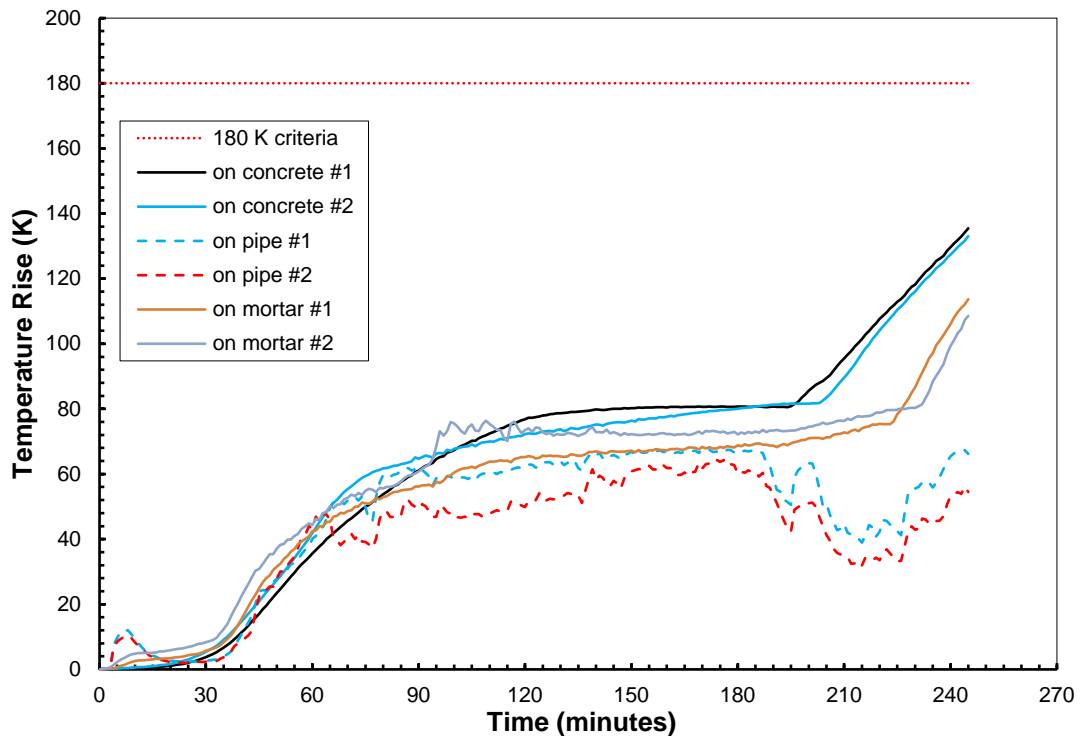

REPORT NUMBER:

**FR 5670**

ISSUE DATE:

**6 September 2016**

PAGE:

**33 of 65**

PCRC

ES

THE LEGAL VALIDITY OF THIS REPORT CAN ONLY BE CLAIMED ON PRESENTATION OF THE COMPLETE SIGNED PAPER REPORT. EXTRACTS OR ABRIDGMENTS OF THIS REPORT SHALL NOT BE PUBLISHED WITHOUT PERMISSION FROM BRANZ LTD.

Figure 31: Specimen 18 temperature rise

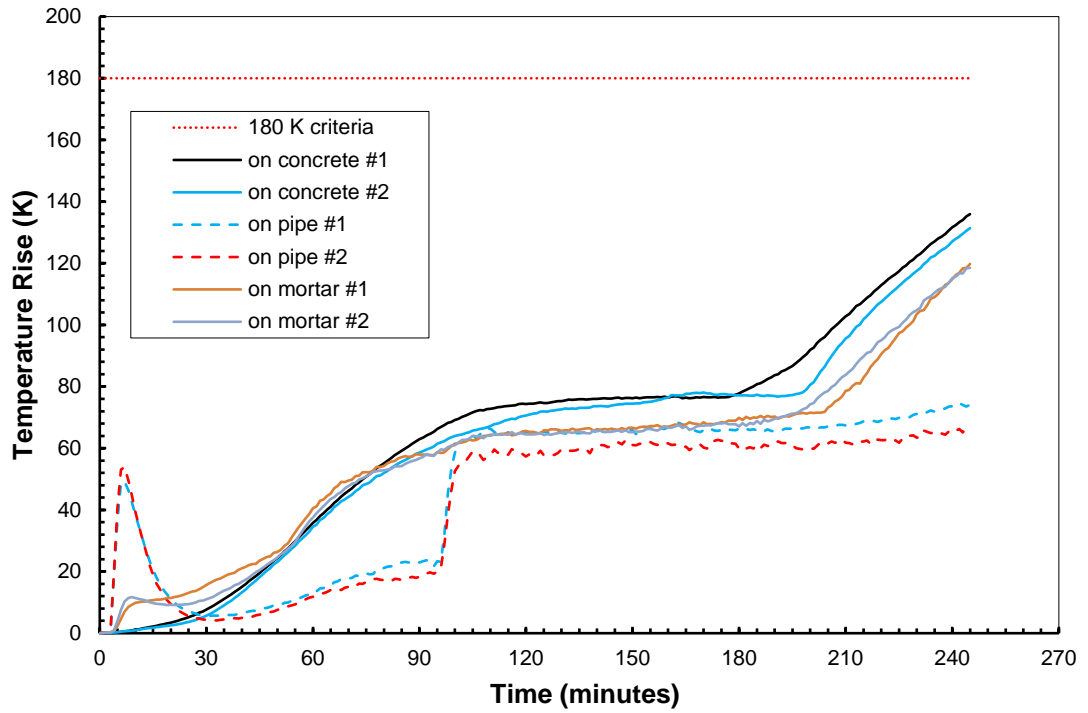
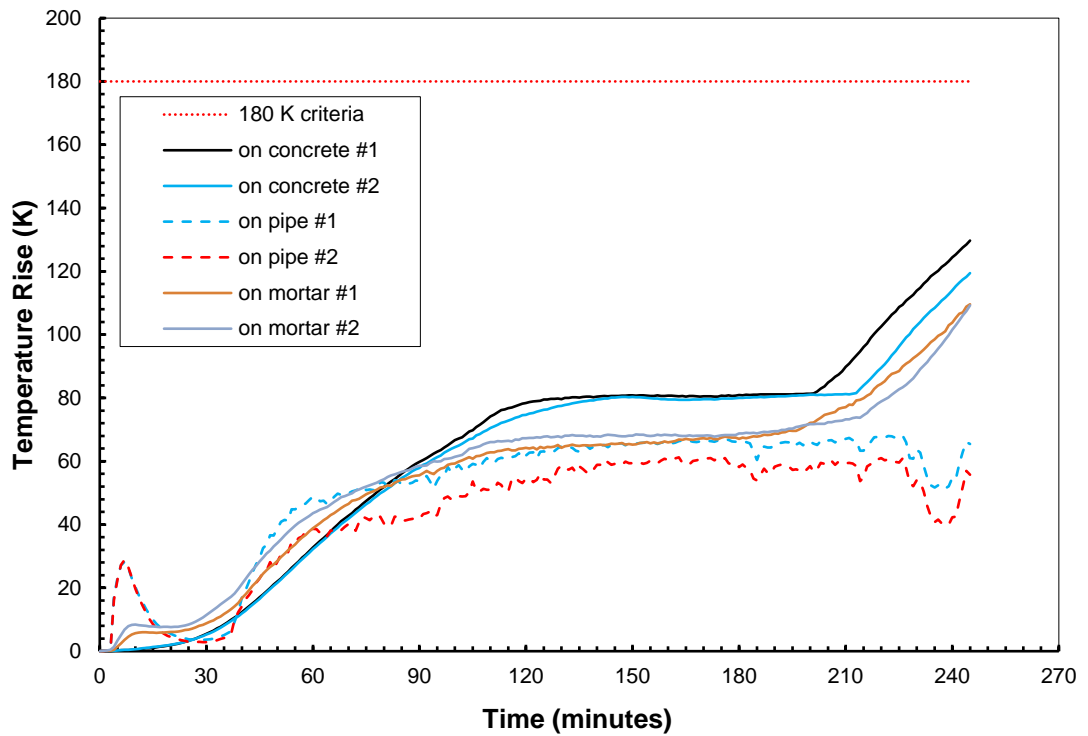

Figure 32: Specimen 19 temperature rise



REPORT NUMBER:

**FR 5670**

ISSUE DATE:

**6 September 2016**

PAGE:

**34 of 65**

PCRC

ES

THE LEGAL VALIDITY OF THIS REPORT CAN ONLY BE CLAIMED ON PRESENTATION OF THE COMPLETE SIGNED PAPER REPORT. EXTRACTS OR ABRIDGMENTS OF THIS REPORT SHALL NOT BE PUBLISHED WITHOUT PERMISSION FROM BRANZ LTD.

**Figure 33: Specimen 20 temperature rise**

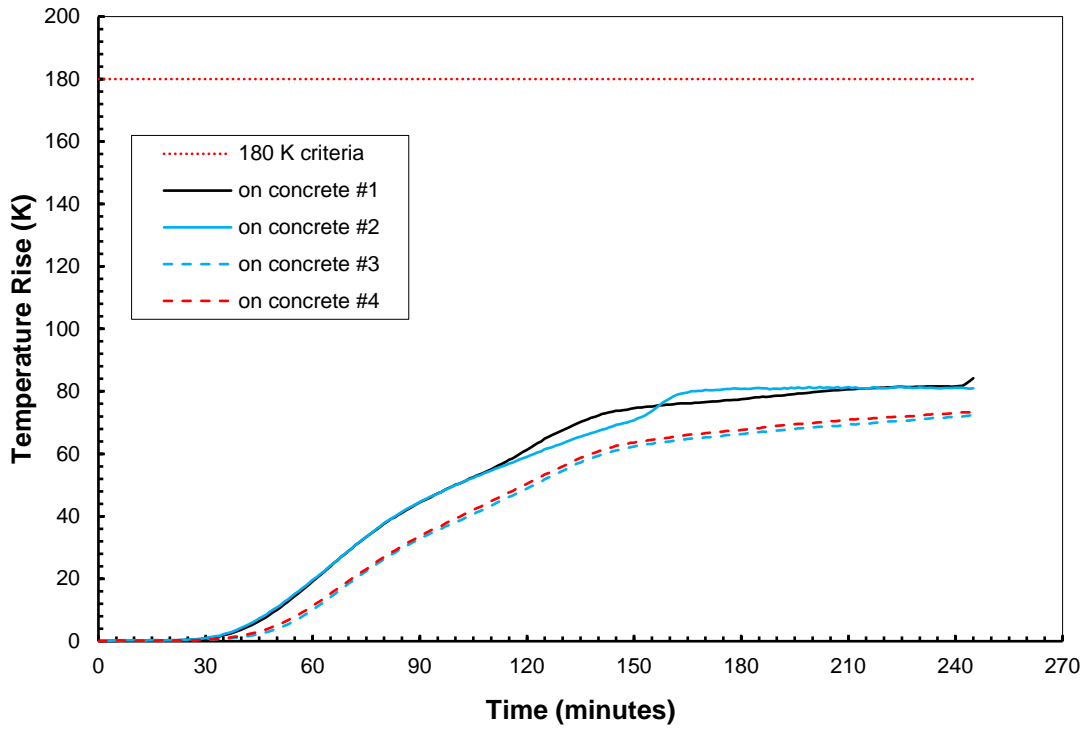

**Figure 34: Specimen 22 temperature rise**

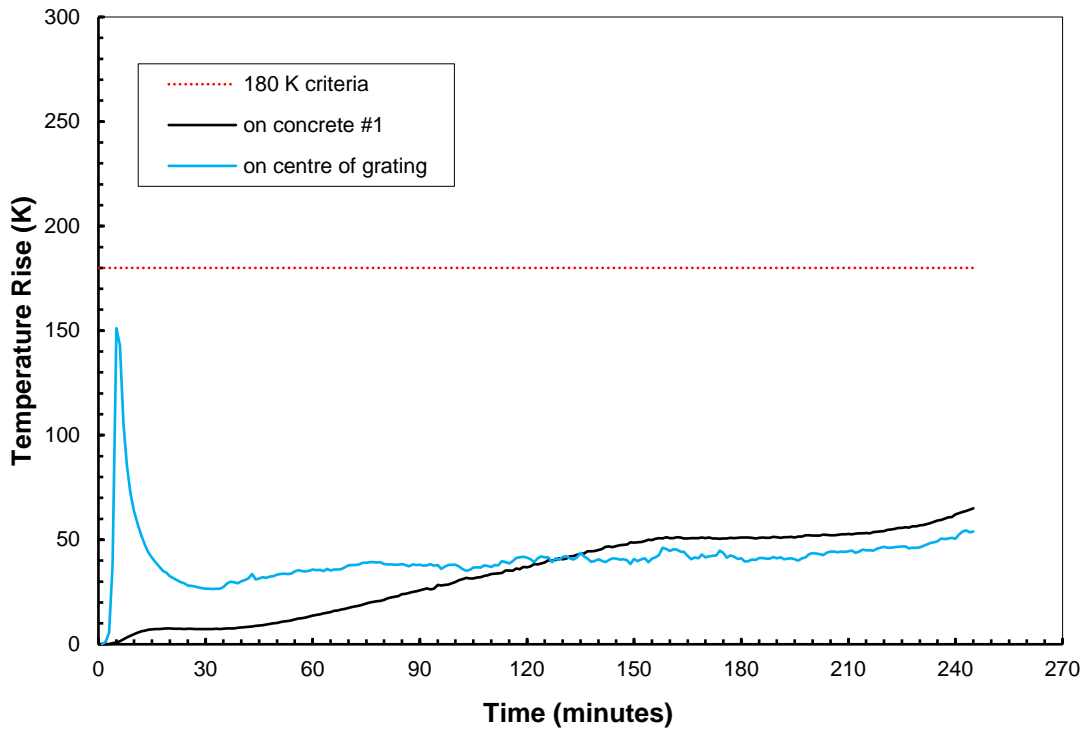

REPORT NUMBER:

**FR 5670**

ISSUE DATE:

**6 September 2016**

PAGE:

**35 of 65**

PCRC

ES

**Figure 35: Specimen 23 temperature rise**

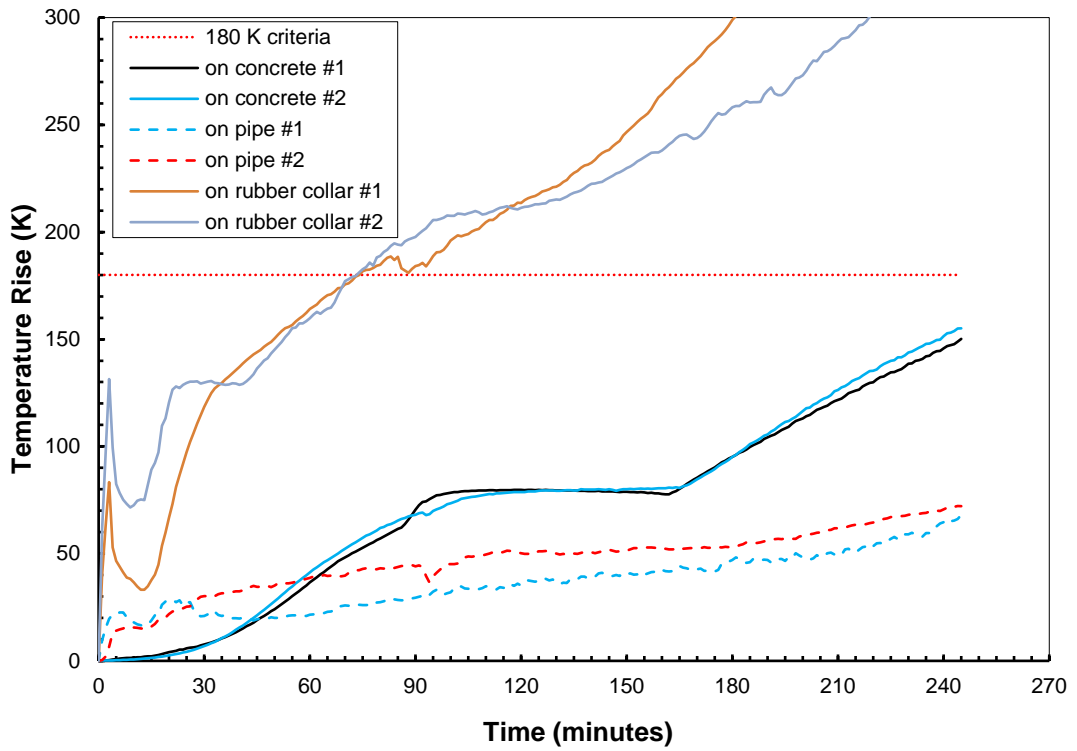

**Figure 36: Specimen 24 temperature rise**

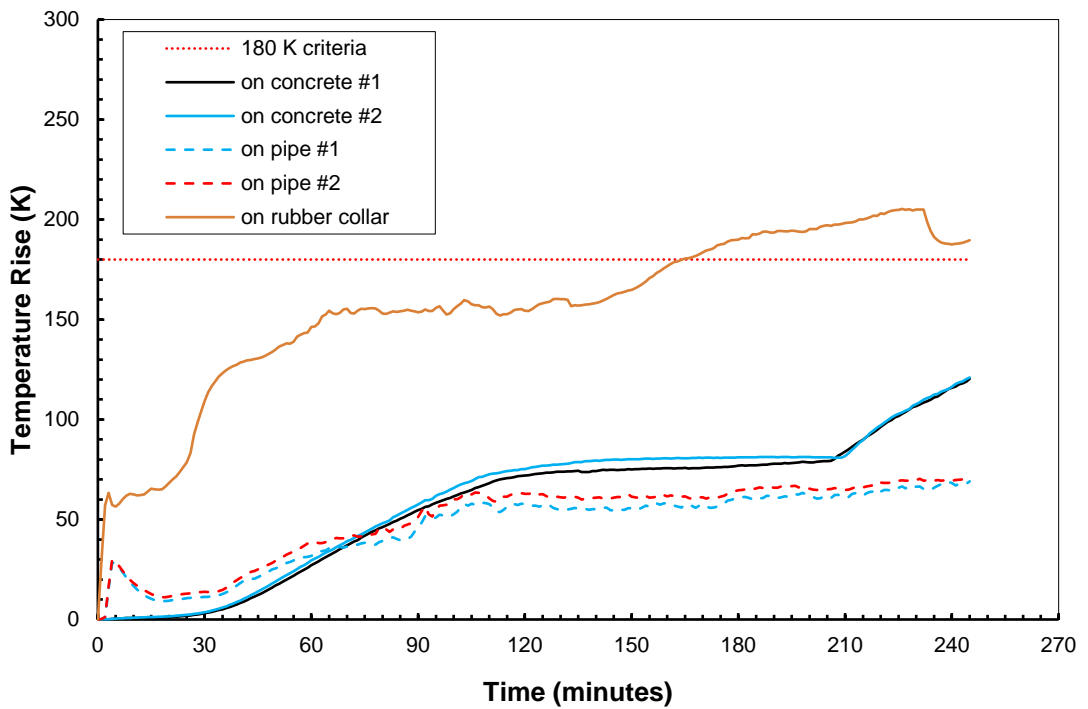

REPORT NUMBER:

**FR 5670**

ISSUE DATE:

**6 September 2016**

PAGE:

**36 of 65**

PCRC

ES

THE LEGAL VALIDITY OF THIS REPORT CAN ONLY BE CLAIMED ON PRESENTATION OF THE COMPLETE SIGNED PAPER REPORT.  
EXTRACTS OR ABRIDGMENTS OF THIS REPORT SHALL NOT BE PUBLISHED WITHOUT PERMISSION FROM BRANZ LTD.

**Figure 37: Specimen 26 temperature rise**

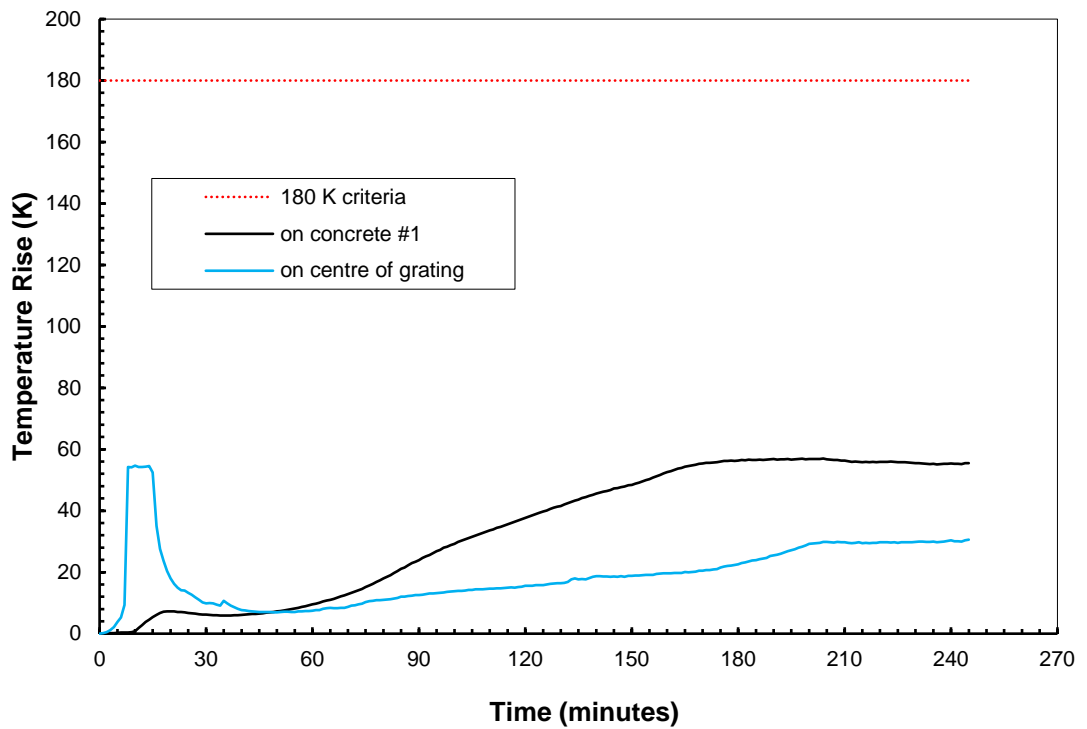

**Figure 38: Specimen 27 temperature rise**

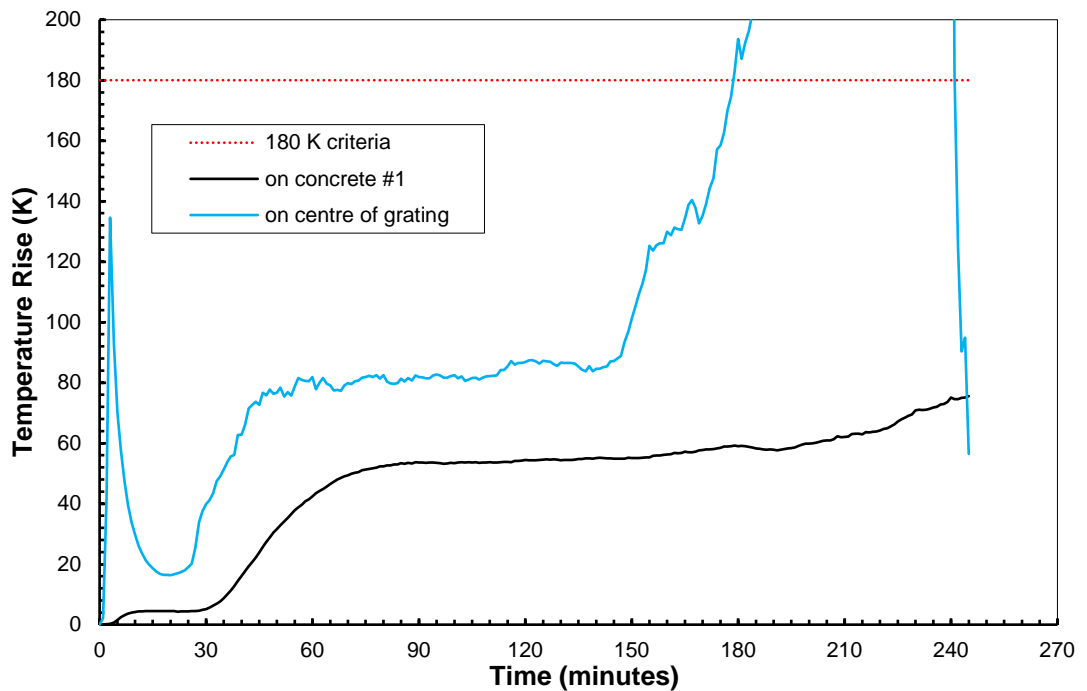

REPORT NUMBER:

**FR 5670**

ISSUE DATE:

**6 September 2016**

PAGE:

**37 of 65**

PCRC

ES

THE LEGAL VALIDITY OF THIS REPORT CAN ONLY BE CLAIMED ON PRESENTATION OF THE COMPLETE SIGNED PAPER REPORT.  
EXTRACTS OR ABRIDGMENTS OF THIS REPORT SHALL NOT BE PUBLISHED WITHOUT PERMISSION FROM BRANZ LTD.

**Figure 39: Specimen 28 temperature rise**

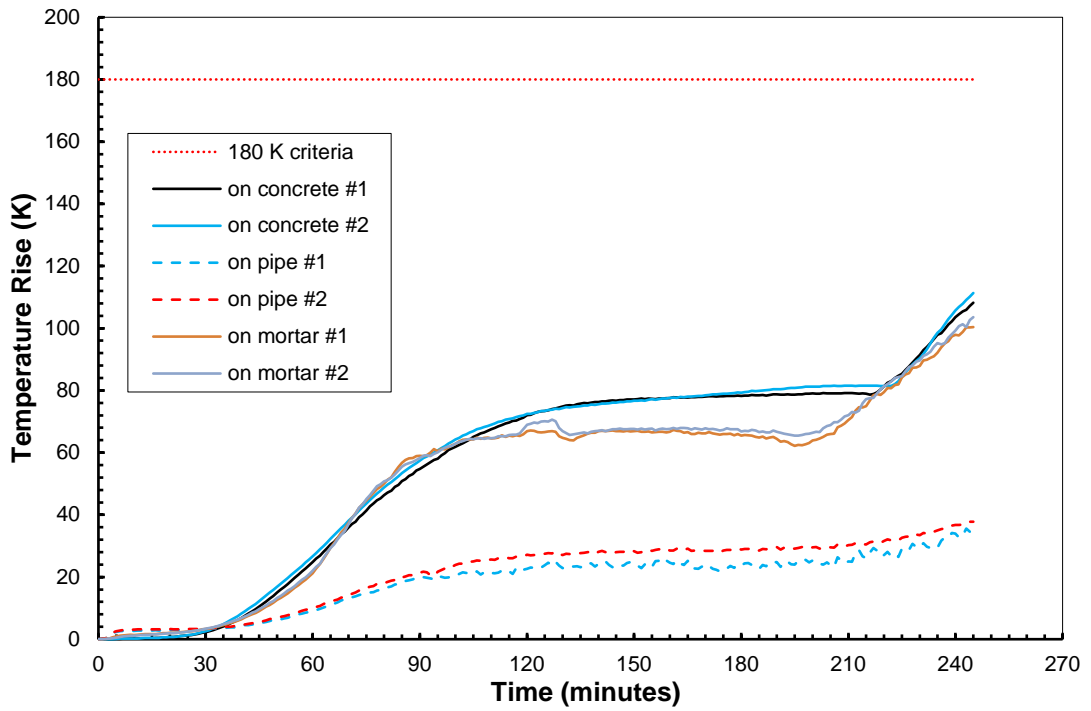

**Figure 40: Specimen 29 temperature rise**

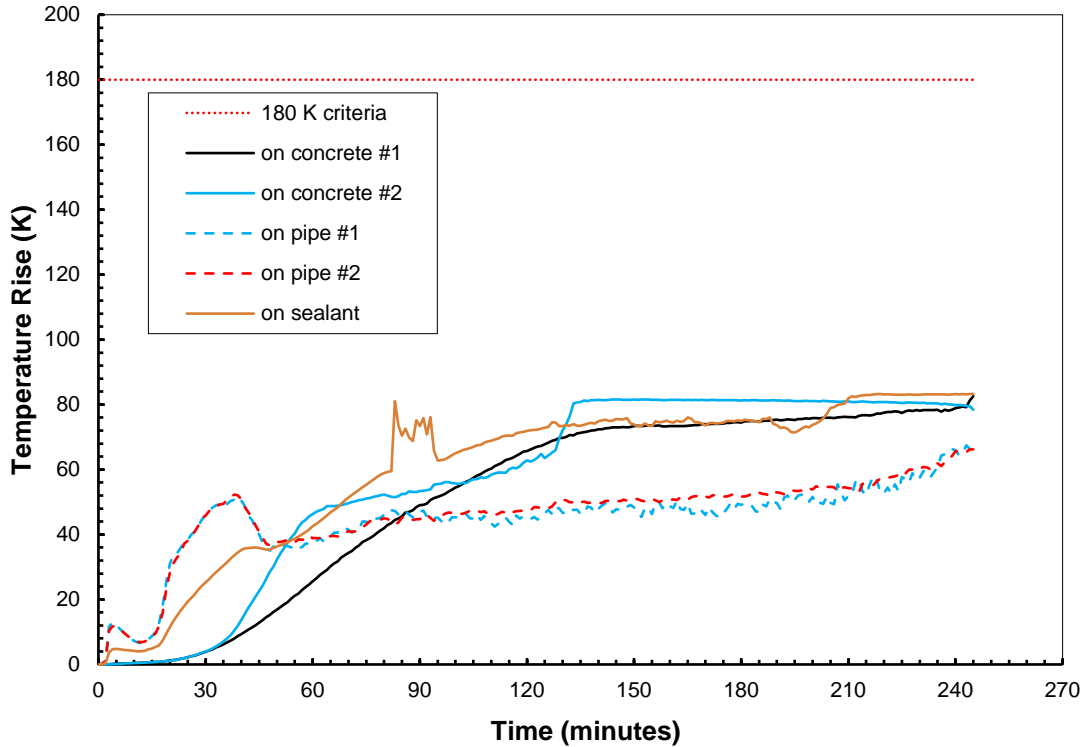

REPORT NUMBER:

**FR 5670**

ISSUE DATE:

**6 September 2016**

PAGE:

**38 of 65**

PCRC

ES

THE LEGAL VALIDITY OF THIS REPORT CAN ONLY BE CLAIMED ON PRESENTATION OF THE COMPLETE SIGNED PAPER REPORT.  
EXTRACTS OR ABRIDGMENTS OF THIS REPORT SHALL NOT BE PUBLISHED WITHOUT PERMISSION FROM BRANZ LTD.

**Figure 41: Temperature rise on concrete slab**

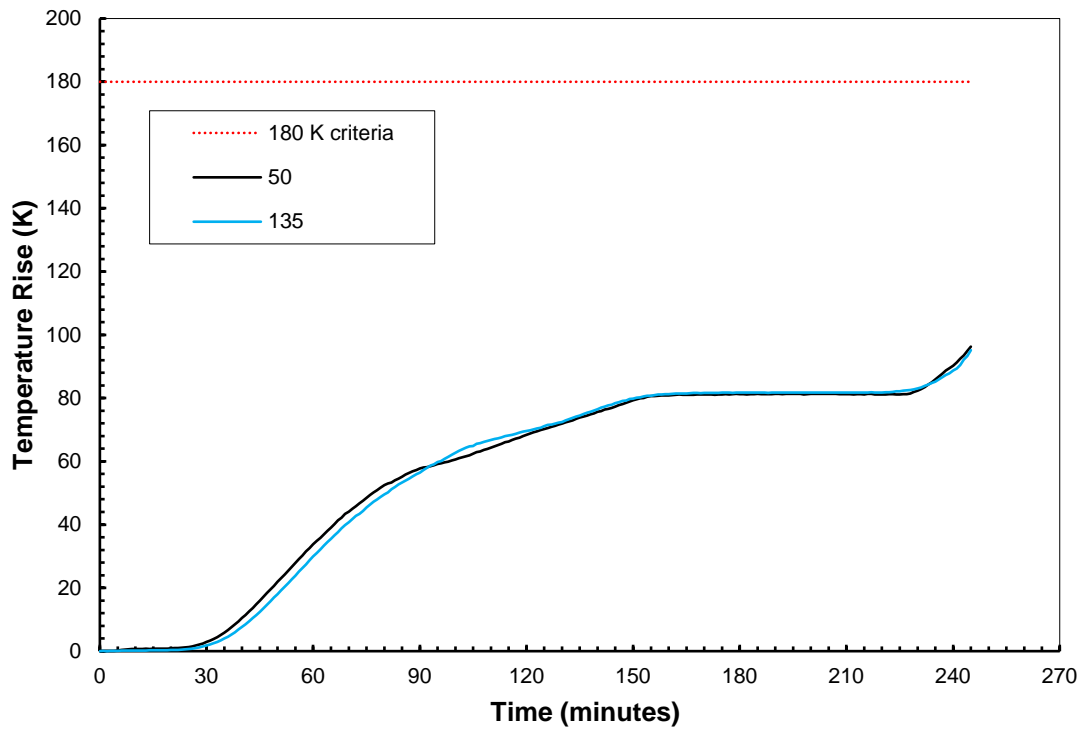

### 3.6 Specimen insulation

**Table 3: Specimen Insulation failures**

Specimen No.	Time (minutes) until which failure occurred (T>180K)	Location of Insulation Failure
1	159	On centre of grating
2	245 NF	
3	245 NF	
4	200	On concrete
5	125	On concrete
6	203	On concrete
7	245 NF	
8	245 NF	
9	207	On concrete
10	213	On pipe
11	245 NF	



REPORT NUMBER:

**FR 5670**

ISSUE DATE:

**6 September 2016**

PAGE:

**39 of 65**



Specimen No.	Time (minutes) until which failure occurred (T>180K)	Location of Insulation Failure
12	245 NF	
13	245 NF	
14	245 NF	
15	245 NF	
16	245 NF	
17	245 NF	
18	245 NF	
19	245 NF	
20	245 NF	
22	245 NF	
23	73	On rubber collar
24	164	On rubber collar
26	245 NF	
27	178	On centre of grating
28	245 NF	
29	245 NF	

### 3.7 Observations

Time mm:ss	Specimen No.	Observation
0:00		Start of test.
1:15	27	A small amount of smoke was being emitted from the top of the grille.
1:50	27	An increase in smoke from the top of the grille.
2:03	3	Smoke was being emitted from the top of the grille.
2:05	27	A decrease in the smoke being emitted from the top of the grille.
2:17	1	Smoke was being emitted from the top of the grille.
2:40	3	A small amount of smoke was being emitted from the top of the grille
2:40	24	Smoke was being emitted from the top of the pipe.
2:45	1	Large amount of smoke was being emitted from grille.
3:00	3	The emitted smoke volume was reducing.
3:05	1	A large volume of smoke was being emitted from the grille.



REPORT NUMBER:

**FR 5670**

ISSUE DATE:

**6 September 2016**

PAGE:

**40 of 65**

PCRC

ES



Time mm:ss	Specimen No.	Observation
3:05	11, 12, 14 & 15	Small amounts of smoke were being emitted at floor penetrations.
3:29	2	Smoke was being emitted from the grille.
3:40	24	The smoke being emitted from the top of the pipe had stopped.
3:47	4, 9 and 10	Smoke was being emitted from the top of the pipes.
4:08	22	A small volume of smoke was being emitted from the grille.
4:17	1, 2	The smoke being emitted was reducing.
4:55	4	A large volume of smoke was being emitted from the top of pipe.
4:56	6	Smoke was being emitted from top of pipe.
5:20	5,7,8, 9	Smoke was being emitted from top of pipe.
5:20	22	Smoke had mostly stopped being emitted out of the top of the grille.
5:48	4	A large volume of smoke was being emitted from the top of pipe.
6:00	16, 17, 18 & 19	A constant volume of smoke was being emitted top of pipes.
6:32	1, 2, 3	The volume of smoke being emitted had significantly reduced.
6:35	-	The volume of smoke being emitted was reducing from all penetrations.
7:20	18	The smoke being emitted at top of pipe had stopped.
7:33	4	The sealant at the slab was sagging with smoke being emitted.
7:50	16	A large volume of smoke was being emitted from the top of pipe.
8:27	3	Wisps of smoke were being emitted from grille.
8:30	4	A small gap at the sealant against slab had opened up.
9:15	5	The sealant on the pipe concrete interface was deforming.
9:34	17 & 19	The smoke being emitted from the top of the pipes had stopped.
10:24	15	A small volume of smoke was being emitted at the floor/pipe sealant.
10:27	5, 6, 9	Smoke was being emitted from top of pipe.
10:53	4	Smoke had ceased being emitted.
12:41	16	Smoke being emitted from the top of pipe had stopped.
13:52	4, 5, 6, 9	Small volumes of smoke were being emitted from the top of pipes.
15:00	4, 5	The portions of pipes between the bottom clamps and the slab were deforming.
15:23	26	Smoke was being emitted from the grille.
15:40	16 & 17	A small volume of smoke was being emitted from the floor/pipe sealant.



REPORT NUMBER:

**FR 5670**

ISSUE DATE:

**6 September 2016**

PAGE:

**41 of 65**



Time mm:ss	Specimen No.	Observation
17:48	1	A small volume of smoke was being emitted from the grille.
20:00	1, 4, 5	A small volume of smoke was being emitted from the grille and the top of the pipes.
22:29	4, 5	A volume of smoke was being emitted at the floor/pipe sealant.
26:00	10,	A small volume of smoke was being emitted from the floor/pipe grout.
26:00	11, 13 & 15	A small volume of smoke was being emitted from the floor/pipe sealant.
29:00	10	A small volume of smoke was being emitted from the floor/pipe sealant.
30:05	5	A small volume of smoke was being emitted from the pipe.
30:10	10, 14	A small volume of smoke was being emitted from the floor/pipe sealant.
34:19	1	A small volume of smoke was being emitted from the grille.
34:24	4	Intumescent material was visible above the slab.
34:30	5	A small volume of smoke was being emitted from the top of pipe.
34:35	10	A small volume of smoke was being emitted from the floor/pipe sealant.
36:30	11, 14 & 15	A small volume of smoke was being emitted from the floor/pipe sealant.
37:00	4	A small volume of smoke was being emitted from the floor/pipe sealant.
40:20	11, 14, 15	A small volume of smoke was being emitted from the floor/pipe sealant.
40:25	21	A volume of smoke was being emitted from the grille.
41:44	4	More intumescent at slab and smoke from sealant.
45:00	1	A volume of smoke was being emitted from the grille.
45:05	4	A small volume of smoke was being emitted from the floor/pipe sealant.
45:10	5	A small volume of smoke was being emitted from the top of pipe
45:15	10-15	A small volume of smoke was being emitted from the floor/pipe sealant.
45:20	21	A volume of smoke was being emitted from the grille.
47:46	10	A volume of smoke was being emitted from the top of the pipe.
52:00	27	A small amount of smoke was being emitted from the top of the grille.
54:00	10	The smoke that was being emitted from the top of the pipe had stopped.
55:52	10	The floor/pipe sealant was cracking.



REPORT NUMBER:

**FR 5670**

ISSUE DATE:

**6 September 2016**

PAGE:

**42 of 65**

PCRC

ES

Time mm:ss	Specimen No.	Observation
60:00	10 & 12	A volume of smoke was being emitted from the top of the pipes.
60:050	4	A small volume of smoke was being emitted from the floor/pipe sealant.
60:10	5	A volume of smoke was being emitted from the top of the pipe.
60:15	10	A small volume of smoke was being emitted from the floor/pipe sealant.
67:00	15	Steam was being emitted from the floor/pipe sealant.
71:45	1	Increasing volumes of smoke were being emitted from the floor/pipe sealant was increasing.
71:50	2, 3	A volume of smoke was being emitted from the top of the pipe again.
75:00	23	The intumescent material had started to melt and distort around the floor/pipe junction where no sealant had been applied.
76:45	12	A small volume of smoke was being emitted from the top of the pipe.
91:00	22	The grille had popped slightly upwards.
94:35	5	The pipe was softening at base and the sealant was swelling.
99:11	27	The grille was rising
102:00	1	The grille had risen very slightly.
106:16	4	The pipe had risen taking the thermocouple upwards. A check with the roving thermocouple at 25 mm height indicated the temperature was 60°C
108:00	10	The smoke being emitted from the top of the pipe had stopped.
108:00	13	A small volume of smoke was being emitted from the top of the pipe.
111:07	5	The pipe had softened some more at base and the sealant was continuing to swell.
113:19	1, 2, 3	There was an increase in the volume of smoke being emitted from the grilles.
113:25	29	The sealant was swelling in gap
114:10	5	The pipe had risen upwards about 75 mm and the thermocouple was re-positioned at 25 mm.
117:30	5	A small volume of smoke was being emitted from the top of the pipe.
118:10	9	There was liquid sealant appearing on the sealant at the edge of the pipe.
120:00	All	All penetrations remained intact. The floor had deflected towards furnace in centre.
125:00	29	The intumescent material had swollen up around the base of the pipe.
128:00	10-15	A small volume of smoke was being emitted from the floor/pipe sealants.



REPORT NUMBER:

**FR 5670**

ISSUE DATE:

**6 September 2016**

PAGE:

**43 of 65**

PCRC

ES

Time mm:ss	Specimen No.	Observation
128:15	22	The grille risen up on one edge and a volume of smoke was being emitted from the grille.
128:20	23, 24	Swelling in annular space.
128:25	27	A volume of smoke was being emitted from the grille.
128:35	29	Softening and swelling at sealant
129:45	27	A larger volume of smoke was being emitted from the grille.
131:07	4	The pipe was distorted at the base.
133:00	22, 27	Small volumes of smoke were being emitted from the top of the grilles.
137:30	12, 13	Very small volumes of smoke were being emitted from the tops of the pipes.
137:58	1	The volume of smoke being emitted from grille was increasing.
140:03	5	Smoke appearing from top of pipe.
146:25	5	Smoke was being emitted at the pipe/floor junction base and from the top of the pipe.
153:40	1	A cotton pad test was applied over the top of the grille. There was a slight discolouration of the cotton pad. No Failure
179:18	1	Another cotton pad test was applied over the top of the grille. There was a slight discolouration of the cotton pad, No failure.
182:05	2, 3	Glowing was visible through grilles.
183:00	22	The grille had risen above slab.
183:05	23, 24	Swelling was observed in annular space between the pipes and the hole in the concrete. These gaps had not been filled with sealant.
188:00	1	The cotton pad test was applied and there was significant blackening, no failure. But flaming was visible below grille.
192:50	5	A large volume of smoke and ash was being emitted from the end of the pipe.
195:27	5	The cotton pad test was applied at the base where the pipe was distorted and glowing was observed, without failure. Shortly after this the pipe burnt through and flames in excess of 10 seconds were observed. <b>This is deemed to be integrity failure in accordance with the standard.</b> A ceramic fibre blanket was placed over the area of flaming and water was used to extinguish the flames.
201:00	27	Glowing was visible from below the grille along with increased volumes of smoke from the grille.
205:00	10	A steady volume of smoke was being emitted from the top of the pipe. The base of the pipe did not show any significant signs of distortion.
207:00	27	There was an increase in the volume of smoke being emitted from the grill. A cotton pad test was applied over



REPORT NUMBER:

**FR 5670**

ISSUE DATE:

**6 September 2016**

PAGE:

**44 of 65**

PCRC

ES

Time mm:ss	Specimen No.	Observation
		the top of the grille with a slight discolouration of the cotton pad.
216:45	1	A cotton pad test was applied over the top of the grille. Blackening with a small amount of glowing and no ignition. <b>This is deemed to be integrity failure in accordance with the standard.</b>
225:09	4	Black intumescent visible at base.
236:00	23	The (white) material in annular space was continuing to swell.
236:10	7	A steady volume of smoke was being emitted from the top of the pipe.
244:10	27	A cotton pad test was applied over the top of the grille. Slight blackening with no glowing and no ignition.
245:15		Test stopped



REPORT NUMBER:

**FR 5670**

ISSUE DATE:

**6 September 2016**

PAGE:

**45 of 65**



### 3.8 Integrity

Integrity failures were recorded as follows.

Pipe Specimen	Time (minutes) which Integrity failure occurred	Integrity Failure
1	216	Cotton pad glowing
2	245 NF	-
3	245 NF	-
4	245 NF	-
5	195	Flaming in excess of 10 seconds
6	245 NF	-
7	245 NF	-
8	245 NF	-
9	245 NF	-
10	245 NF	-
11	245 NF	-
12	245 NF	-
13	245 NF	-
14	245 NF	-
15	245 NF	-
16	245 NF	-
17	245 NF	-
18	245 NF	-
19	245 NF	-
20	245 NF	-
22	245 NF	-
23	245 NF	-
24	245 NF	-
26	245 NF	-
27	245 NF	-
28	245 NF	-
29	245 NF	-



REPORT NUMBER:

**FR 5670**

ISSUE DATE:

**6 September 2016**

PAGE:

**46 of 65**



## 4. CONCLUSION

The fire resistance in minutes, in accordance with AS 1530.4-2005, of 29 pipe penetrations and their sealing systems in a 150 mm thick reinforced concrete slab, was as follows:

Specimen No.	Collar	Pipe	Size (Nom, mm)	Integrity, min	Insulation, min	FRL
1	LP100R-C	PVC	80	216	159	-/180/120
2	H100FWS-RR	PVC-SC	100	245 NF	245 NF	-/240/240
3	H50FWS-RR	PVC	50	245 NF	245 NF	-/240/240
4	H150S-RR	PVC-SC	160	245 NF	200	-/240/180
5	H150S-RR	HDPE	160	195	125	-/180/120
6	H150S-RR	Raupiano	160	245 NF	203	-/240/180
7	H150S-RR	BEP PVC-U-SC	110	245 NF	245 NF	-/240/240
8	H150S-RR	HDPE	125	245 NF	245 NF	-/240/240
9	H150S-RR	Raupiano	100	245 NF	207	-/240/180
10	32R	Pex-a	16	245 NF	213	-/240/180
11	32R	Pex-a	20	245 NF	245 NF	-/240/240
12	32R	Pex-a	25	245 NF	245 NF	-/240/240
13	32R	Pex-b	16	245 NF	245 NF	-/240/240
14	32R	Pex-b	20	245 NF	245 NF	-/240/240
15	32R	Pex-b	25	245 NF	245 NF	-/240/240
16	H50S-RR	Pex-a	16	245 NF	245 NF	-/240/240
17	H50S-RR	Pex-b	16	245 NF	245 NF	-/240/240
18	H50S-RR	Pex-a	20	245 NF	245 NF	-/240/240
19	H50S-RR	Pex-b	20	245 NF	245 NF	-/240/240
20	H100FWS-RR	Blank, 0.4 mm galv steel plate	110	245 NF	245 NF	-/240/240
22	H100FWS-RR	BEP PVC-U-SC	110	245 NF	245 NF	-/240/240
23	H100S-RR	PVC-U	65	245 NF	73	-/240/60
24	H50S-RR	PVC	40	245 NF	164	-/240/120
26	H50FWS-RR	HDPE	50	245 NF	245 NF	-/240/240
27	LP50R	PVC	40	245 NF	178	-/240/120
28	H65S-RR	HDPE	40	245 NF	245 NF	-/240/240
29	H50S-RR	PVC-U	32	245 NF	245 NF	-/240/240



REPORT NUMBER:

**FR 5670**

ISSUE DATE:

**6 September 2016**

PAGE:

**47 of 65**



THE LEGAL VALIDITY OF THIS REPORT CAN ONLY BE CLAIMED ON PRESENTATION OF THE COMPLETE SIGNED PAPER REPORT.  
EXTRACTS OR ABRIDGMENTS OF THIS REPORT SHALL NOT BE PUBLISHED WITHOUT PERMISSION FROM BRANZ LTD.

The test standard requires the following statements to be included:

*"The results of these fire tests may be used to directly assess fire hazard, but it should be recognized that a single test method will not provide a full assessment of fire hazard under all fire conditions."*

*"This report details methods of construction, the test conditions and results obtained when the specific element of construction described herein was tested following the procedure outlined in this standard. Any significant variations with respect to size, constructional details, loads, stresses, edge or end conditions, other than those allowed under the field of direct application in the relevant test method, is not covered by this report."*

*"Because of the nature of fire resistance testing and the consequent difficulty in quantifying the uncertainty of measurement of fire resistance, it is not possible to provide a stated degree of accuracy of the result."*

## 5. PERMISSIBLE VARIATIONS

In accordance with AS 1530.4:2005 clause 10.11, the permissible variations that are relevant to the tested penetration systems reported in FR 5670 are as follows.

- a) The results of the prototype test may be applied to concrete of density 1,757 kg/m<sup>3</sup> to 2,377 kg/m<sup>3</sup> representing  $\pm 15\%$  of that used in test FR 5670.
- b) The test results for plastic pipes given in this report may be directly applied to masonry and concrete elements thicker than 150 mm.
- c) Penetrations not perpendicular to the plane of the element are acceptable provided that the fire-stopping system is installed in a floor slab and penetration dimensions are identical to those given in this report.



REPORT NUMBER:

**FR 5670**

ISSUE DATE:

**6 September 2016**

PAGE:

**48 of 65**

PCRC

A blue ink signature over the text "PCRC" inside a rectangular box.

ES

A blue ink signature over the text "ES" inside a rectangular box.



# PHOTOS

Photo 1: Pre-test unexposed face Specimens 1 to 6



Photo 2: Pre-test unexposed face Specimens 7 to 15



**Photo 3: Pre-test unexposed face Specimens 16 to 20**



**Photo 4: Pre-test unexposed face Specimens 22 to 29**



Photo 5: Pre-test exposed face



Photo 6: Start of test unexposed face



REPORT NUMBER:

**FR 5670**

ISSUE DATE:

**6 September 2016**

PAGE:

**51 of 65**

PCRC

*PCRC*

ES

*ES*

THE LEGAL VALIDITY OF THIS REPORT CAN ONLY BE CLAIMED ON PRESENTATION OF THE COMPLETE SIGNED PAPER REPORT.  
EXTRACTS OR ABRIDGMENTS OF THIS REPORT SHALL NOT BE PUBLISHED WITHOUT PERMISSION FROM BRANZ LTD.

**Photo 7: Specimen 1, left to right, unexposed, exposed and unexposed post test**



**Photo 8: Specimen 2, left to right, unexposed, exposed and unexposed post test**



**Photo 9: Specimen 3, left to right, unexposed, exposed and unexposed post test**



**Photo 10: Specimen 4, left to right, unexposed, exposed and unexposed post test**



**Photo 11: Specimen 5, left to right, unexposed, exposed and unexposed post test**



**Photo 12: Specimen 6, left to right, unexposed, exposed and unexposed post test**



**Photo 13: Specimen 7, left to right, unexposed, exposed and unexposed post test**



**Photo 14: Specimen 8, left to right, unexposed, exposed and unexposed post test**



**Photo 15: Specimen 9, left to right, unexposed, exposed and unexposed post test**



**Photo 16: Specimen 10, left to right, unexposed, exposed and unexposed post test**





Photo 17: Specimen 11, left to right, unexposed, exposed and unexposed post test

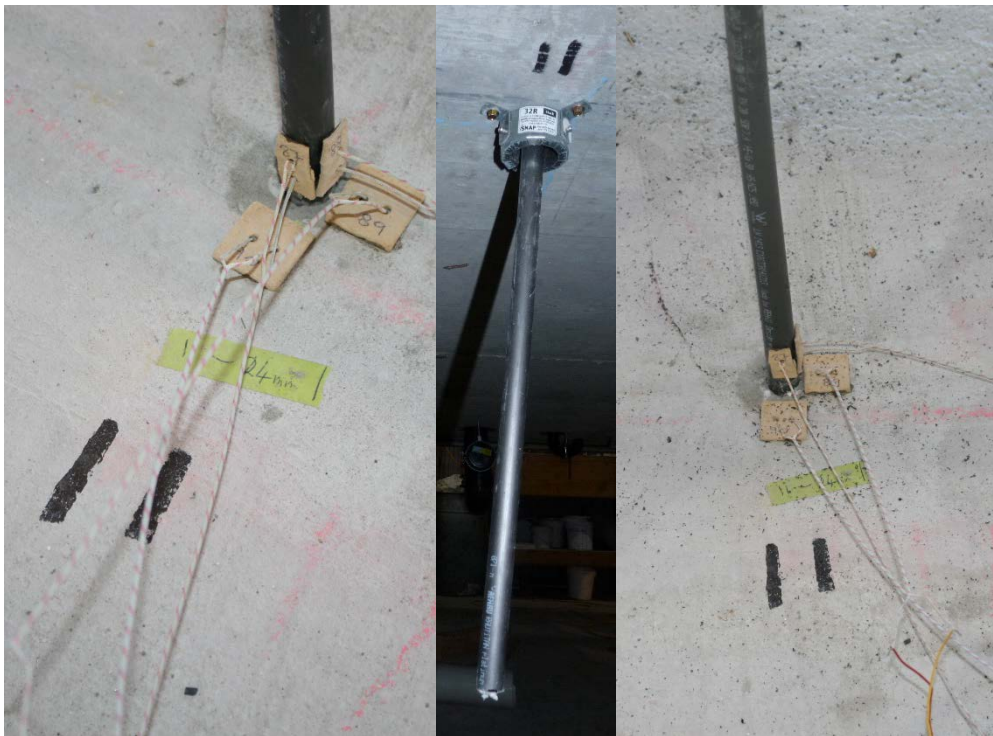
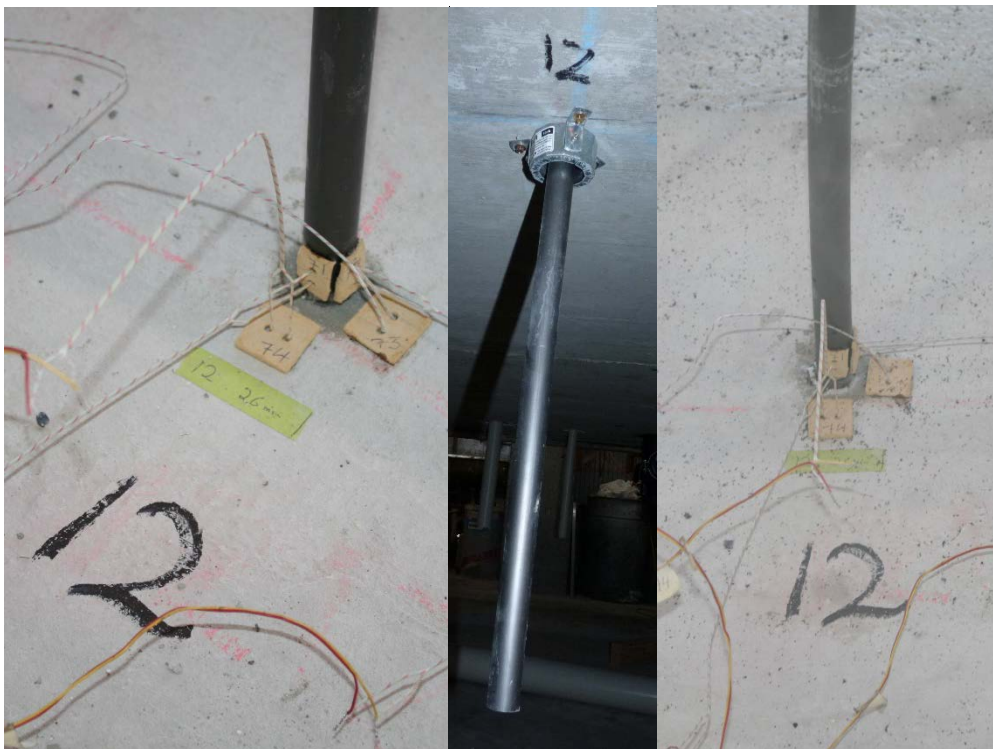
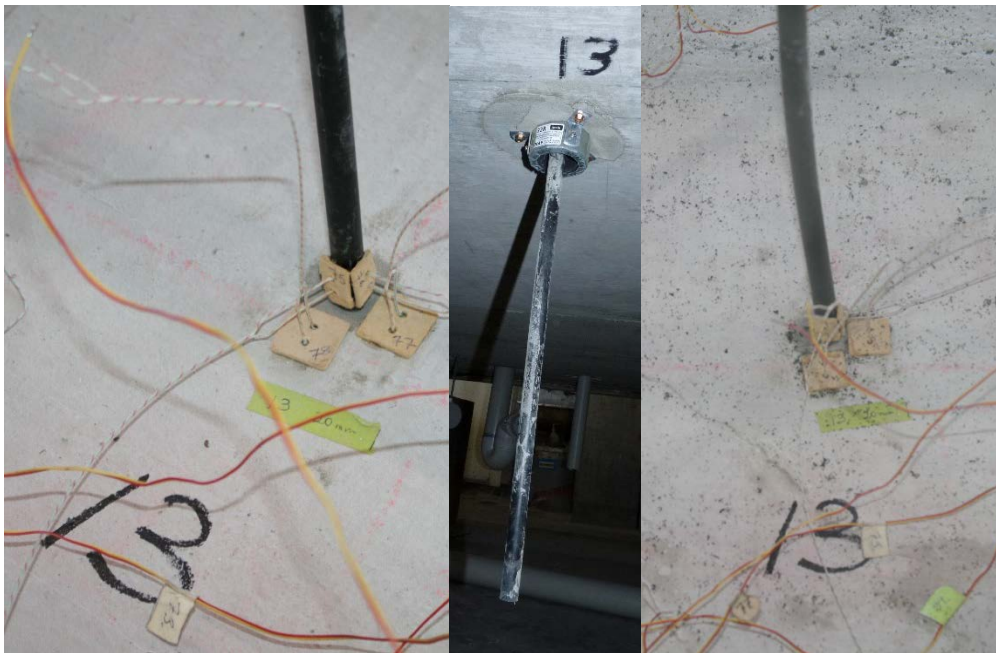

Photo 18: Specimen 12, left to right, unexposed, exposed and unexposed post test



**Photo 19: Specimen 13, left to right, unexposed, exposed and unexposed post test**



**Photo 20: Specimen 14, left to right, unexposed, exposed and unexposed post test**



**Photo 21: Specimen 15, left to right, unexposed, exposed and unexposed post test**



**Photo 22: Specimen 16, left to right, unexposed, exposed and unexposed post test**



**Photo 23: Specimen 17, left to right, unexposed, exposed and unexposed post test**

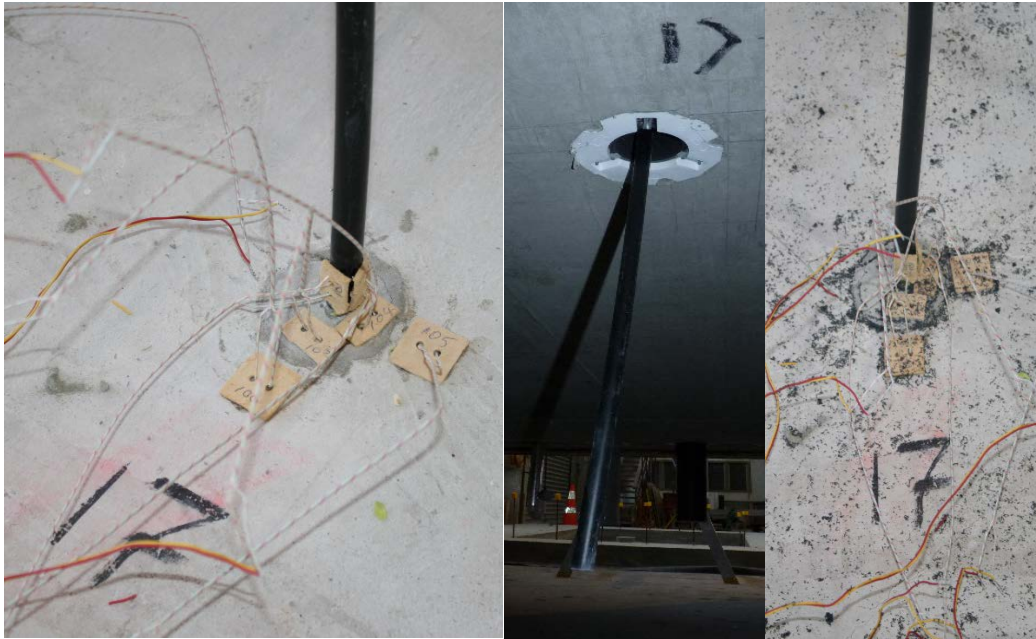

**Photo 24: Specimen 18, left to right, unexposed, exposed and unexposed post test**

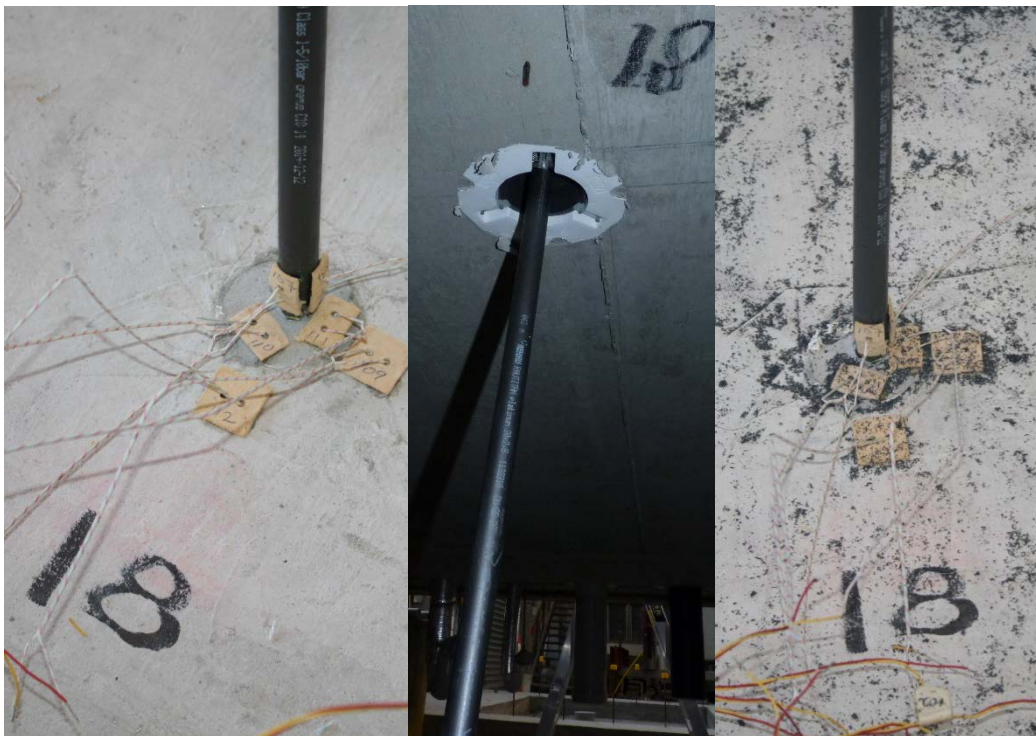

**Photo 25: Specimen 19, left to right, unexposed, exposed and unexposed post test**



**Photo 26: Specimen 20, left to right, unexposed, exposed and unexposed post test**



**Photo 27: Specimen 22, left to right, unexposed, exposed and unexposed post test**



**Photo 28: Specimen 23, left to right, unexposed, exposed and unexposed post test**



**Photo 29: Specimen 24, left to right, unexposed, exposed and unexposed post test**



**Photo 30: Specimen 26, left to right, unexposed, exposed and unexposed post test**



**Photo 31: Specimen 27, left to right, unexposed, exposed and unexposed post test**



**Photo 32: Specimen 28, left to right, unexposed, exposed and unexposed post test**





**Photo 33: Specimen 29, left to right, unexposed, exposed and unexposed post test**

